

SHARP®

ELECTRONIC CASH REGISTER

MODEL

XE-A207W/XE-A207B

XE-A217W/XE-A217B

FULL DETAILED INSTRUCTION MANUAL



The above illustration shows the model XE-A217W/XE-A217B.

CAUTION:

The cash register should be securely fitted to the supporting platform to avoid instability when the drawer is open.

CAUTION:

The socket-outlet shall be installed near the equipment and shall be easily accessible.

VORSICHT:

Die Netzsteckdose muß nahe dem Gerät angebracht und leicht zugänglich sein.

ATTENTION:

La prise de courant murale devra être installée à proximité de l'équipement et devra être facilement accessible.

AVISO:

El tomacorriente debe estar instalado cerca del equipo y debe quedar bien accesible.

WARNING:

Det matande vägguttaget skall placeras nära apparaten och vara lätt åtkomligt.

LET OP:

Het stopcontact dient in de buurt van de kassa en gemakkelijk toegankelijk te zijn.

CAUTION:

For a complete electrical disconnection pull out the mains plug.

VORSICHT:

Zur vollständigen elektrischen Trennung vom Netz den Netzstecker ziehen.

ATTENTION:

Pour obtenir une mise hors-circuit totale, débrancher la prise de courant secteur.

AVISO:

Para una desconexión eléctrica completa, desenchufar el enchufe de tomacorriente.

WARNING:

För att helt koppla från strömmen, dra ut stickproppen.

LET OP:

Trek de stekker uit het stopcontact indien u de stroom geheel wilt uitschakelen.

Authorized representative responsible for the European Union Community Market
Autorisierter Repräsentant in der Europäischen Union
Représentant autorisé pour le marché de la communauté européenne
Representante autorizado responsable para el Mercado Común de la Unión Europea
Auktoriserad representant ansvarig för EU marknaden
Geautoriseerde vertegenwoordiger in de Europese Unie

SHARP ELECTRONICS (Europe) GmbH
Sonninstraße 3, D-20097 Hamburg

INTRODUCTION

Thank you very much for your purchase of the SHARP Electronic Cash Register, Model XE-A207W/XE-A207B/XE-A217W/XE-A217B.

Please read this manual carefully before operating your machine in order to gain full understanding of functions and features.

Please keep this manual for future reference. It will help you if you encounter any operational problems.

IMPORTANT

- Be very careful when removing and replacing the printer cover, as the cutter mounted on it is very sharp.
- Install the cash register in a location not subject to direct sunlight, unusual temperature changes, high humidity or splashing water.
Installation in such locations could cause damage to the cabinet and the electronic components.
- Never install the register in saline areas (e.g.: close to the sea).
Installing the register in such locations could cause component failure with the corrosion.
- Never operate the register with wet hands.
The water could seep into the interior of the register and cause component failure.
- When cleaning your register, use a dry, soft cloth. Never use solvents, such as benzine and/or thinner.
The use of such chemicals will lead to discoloration or deterioration of the cabinet.
- The register plugs into any standard wall outlet (official (nominal) voltage).
Other electrical devices on the same electrical circuit could cause the register to malfunction.
- For protection against data loss, please install two alkaline batteries LR6 ("AA" size) after initializing the cash register. When handling the batteries, please observe the following:
Incorrectly using batteries can cause them to burst or leak, possibly damaging the interior of the cash register.
 - RISK OF EXPLOSION IF BATTERY IS REPLACED BY AN INCORRECT TYPE.
DISPOSE OF USED BATTERIES ACCORDING TO THE INSTRUCTIONS.
 - Be sure that the positive (+) and negative (-) poles of each battery are facing in the proper direction for installation.
 - Never mix batteries of different types.
 - Never mix old batteries and new ones.
 - Never leave dead batteries in the battery compartment.
 - Remove the batteries if you do not plan to use the cash register for long periods.
 - Should a battery leak, clean out the battery compartment immediately, taking care to avoid letting the battery fluid come into direct contact with your skin.
 - For battery disposal, follow the corresponding law in your country.
- For complete electrical disconnection, disconnect the main plug.

CONTENTS

| | |
|---|----|
| INTRODUCTION | 3 |
| IMPORTANT | 3 |
| CONTENTS | 4 |
| 1 Part Names and Functions | 8 |
| External View..... | 8 |
| Front view (XE-A207W/XE-A207B)..... | 8 |
| Front view (XE-A217W/XE-A217B)..... | 8 |
| Rear view (XE-A207W/XE-A207B) (XE-A217W/XE-A217B)..... | 9 |
| Printer..... | 10 |
| Keyboard XE-A207W/XE-A207B..... | 11 |
| Keyboard layout..... | 11 |
| Function key list..... | 11 |
| Keyboard XE-A217W/XE-A217B..... | 12 |
| Keyboard layout..... | 12 |
| Programing keyboard layout..... | 12 |
| Function key list..... | 13 |
| Inserting the keyboard sheet (XE-A217W/XE-A217B only)..... | 14 |
| RS232 Connector/SD Card Slot..... | 15 |
| RS232 connector..... | 15 |
| SD card slot..... | 15 |
| Displays..... | 16 |
| Operator display..... | 16 |
| Customer display..... | 17 |
| Screen save mode..... | 17 |
| 2 Selecting an Operating Mode | 18 |
| Operating Modes..... | 18 |
| Mode Selection..... | 19 |
| 3 Prior to Making Entries | 20 |
| Preparations for Entries..... | 20 |
| Receipt paper roll..... | 20 |
| Receipt ON/OFF function..... | 20 |
| Clerk assignment..... | 20 |
| Error Warning..... | 20 |
| Item Selection from the Menu..... | 21 |
| Starting Cash Memory Entry..... | 21 |
| HELP FUNCTION..... | 22 |
| Printing the help menu..... | 22 |
| Printing guidance messages..... | 22 |
| 4 Entries | 23 |
| Item Entries..... | 23 |
| Single item entries..... | 23 |
| Repeat entries..... | 25 |
| Multiplication entries..... | 26 |
| Split-pricing entries..... | 27 |
| Single item cash sale (SICS)..... | 28 |
| PLU level shift (for direct PLUs) (for XE-A217W/XE-A217B only)..... | 29 |
| Display of Subtotals..... | 30 |
| Subtotal..... | 30 |
| Finalization of Transaction..... | 31 |
| Cash or check tendering..... | 31 |
| Mixed tendering (check + cash)..... | 32 |

| | |
|--|----|
| Cash or check sale that does not need any tender entry | 32 |
| Credit sale | 33 |
| Mixed-tender sale (cash or check tendering + credit tendering)..... | 33 |
| Computation of VAT (Value Added Tax)/Tax | 34 |
| VAT/tax system | 34 |
| VAT shift entries (for XE-A217W/XE-A217B only) | 35 |
| Guest Check..... | 36 |
| Guest look up (GLU) system (for XE-A217W/XE-A217B only) | 36 |
| Table bill copy print (for XE-A217W/XE-A217B only) | 37 |
| Auxiliary Entries..... | 38 |
| Percent calculations (premium or discount) | 38 |
| Discount entries | 39 |
| Refund entries | 39 |
| Printing of non-add code numbers | 40 |
| Payment Treatment | 40 |
| Currency exchange | 40 |
| Received-on-account entries..... | 41 |
| Paid-out entries | 41 |
| No-sale (exchange) | 42 |
| Cashing a check | 42 |
| Electronic Journal View | 42 |
| TRAINING Mode..... | 43 |
| 5 Correction | 44 |
| Correction of the Last Entry (Direct Void) | 44 |
| Correction of the Next-to-Last or Earlier Entries (Indirect Void)..... | 45 |
| Subtotal Void..... | 46 |
| Correction after Finalizing a Transaction..... | 46 |
| 6 Special Printing Function | 47 |
| Copy Receipt Printing | 47 |
| Guest Check Receipt(Bill Print) | 48 |
| 7 Manager Mode | 49 |
| Entering the Manager Mode | 49 |
| Override Entries..... | 49 |
| 8 Reading (X) and Resetting (Z) of Sales Totals | 50 |
| How to take a X1/Z1 or X2/Z2 report..... | 50 |
| Flash report | 50 |
| Daily Sales Totals | 52 |
| General report | 52 |
| PLU report by designated range..... | 55 |
| PLU report by associated department..... | 55 |
| Individual clerk report | 56 |
| All clerk report | 56 |
| Hourly report..... | 57 |
| GLU report (for XE-A217W/XE-A217B only)..... | 57 |
| GLU report by clerk (for XE-A217W/XE-A217B only)..... | 58 |
| Balance report (for XE-A217W/XE-A217B only) | 58 |
| Periodic Report Sample..... | 59 |
| General information | 59 |
| 9 Prior to Programming | 60 |
| Programming Keyboard Layout..... | 60 |
| How to Program Alphanumeric Characters | 62 |
| Mobile phone method (XE-A207W/XE-A207B only) | 62 |
| PC keyboard method (XE-A217W/XE-A217B)..... | 62 |

| | |
|--|-----|
| Entering character codes..... | 63 |
| 10 Programming | 64 |
| Basic Instructions..... | 64 |
| Programming screen..... | 64 |
| Programming example..... | 65 |
| Article Programming..... | 67 |
| Department..... | 68 |
| PLU..... | 69 |
| PLU range..... | 70 |
| Functional Programming..... | 71 |
| Discount (⊖)..... | 72 |
| Percent (%1, %2)..... | 73 |
| RA..... | 73 |
| PO..... | 74 |
| CID (Cash in drawer)..... | 74 |
| CHK/CG (Check change)..... | 74 |
| Check cashing..... | 75 |
| Media Key Programming..... | 76 |
| Cash key (Cash)..... | 77 |
| Check key (Check1, Check2)..... | 77 |
| Credit key (Credit1, Credit2)..... | 78 |
| Foreign currency (Exchange1, Exchange2)..... | 79 |
| Function Text Programming..... | 80 |
| Personnel Programming..... | 82 |
| Clerk..... | 82 |
| Manager..... | 83 |
| Mode Pass Code..... | 83 |
| Training Clerk..... | 84 |
| Terminal Programming..... | 85 |
| Date/Time Setting..... | 86 |
| Date/time..... | 86 |
| Optional Feature Selection..... | 87 |
| Basic System..... | 88 |
| Rounding..... | 89 |
| Function Prohibit..... | 90 |
| Function Authority..... | 91 |
| Function Selection..... | 92 |
| Print Selection..... | 93 |
| Exchange Function..... | 94 |
| EURO Change..... | 95 |
| Report Programming..... | 96 |
| Zero skip..... | 97 |
| Print select..... | 97 |
| Z Counter..... | 98 |
| Z1 General report..... | 99 |
| Hourly report..... | 99 |
| Electronic Journal..... | 99 |
| Message Programming..... | 100 |
| Receipt logo..... | 100 |
| Device Configuration Programming..... | 101 |
| Keyboard..... | 101 |
| Display..... | 102 |
| Printer..... | 102 |

| | |
|--|------------|
| Online | 102 |
| Tax Programming..... | 103 |
| Tax system..... | 103 |
| Tax 1 through 4..... | 103 |
| Automatic Sequencing Key Programming | 104 |
| Key Text..... | 104 |
| Key Sequence | 105 |
| Reading of Stored Programs | 106 |
| Program reading sequence | 106 |
| Sample printouts..... | 107 |
| SD CARD Mode..... | 115 |
| Inserting and removing an SD memory card | 115 |
| SD card formatting..... | 115 |
| Folder creating..... | 115 |
| Folder name selecting | 116 |
| Data saving | 116 |
| Data loading | 117 |
| 11 Electronic Journal | 118 |
| Electronic journal | 118 |
| 12 EURO Migration Function | 119 |
| 13 Operator Maintenance | 121 |
| In Case of Power Failure | 121 |
| In Case of Printer Error..... | 121 |
| Cautions in Handling the Printer and Recording Paper | 121 |
| Cautions in handling the printer..... | 121 |
| Cautions in handling the recording paper (thermal paper) | 121 |
| Installing Batteries | 122 |
| Replacing the Paper Roll..... | 124 |
| Recording paper specifications | 124 |
| Installing the Paper Roll..... | 124 |
| Removing the receipt paper roll..... | 126 |
| Removing the Paper Jam | 126 |
| Cleaning the Printer (Printer Head/Sensor/Roller)..... | 127 |
| Removing the Till and the Drawer..... | 128 |
| Opening the Drawer by Hand | 128 |
| Drawer Lock Key | 128 |
| Installing the Fixing Angle Bracket..... | 129 |
| Before Calling for Service..... | 130 |
| 14 Specifications | 131 |

1 Part Names and Functions

External View

■ Front view (XE-A207W/XE-A207B)

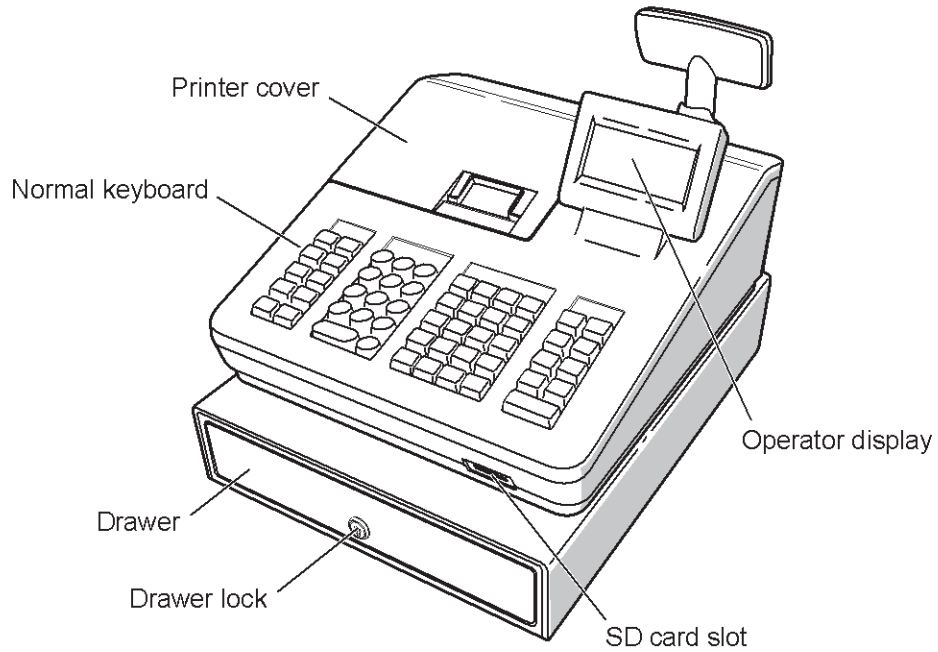

■ Front view (XE-A217W/XE-A217B)

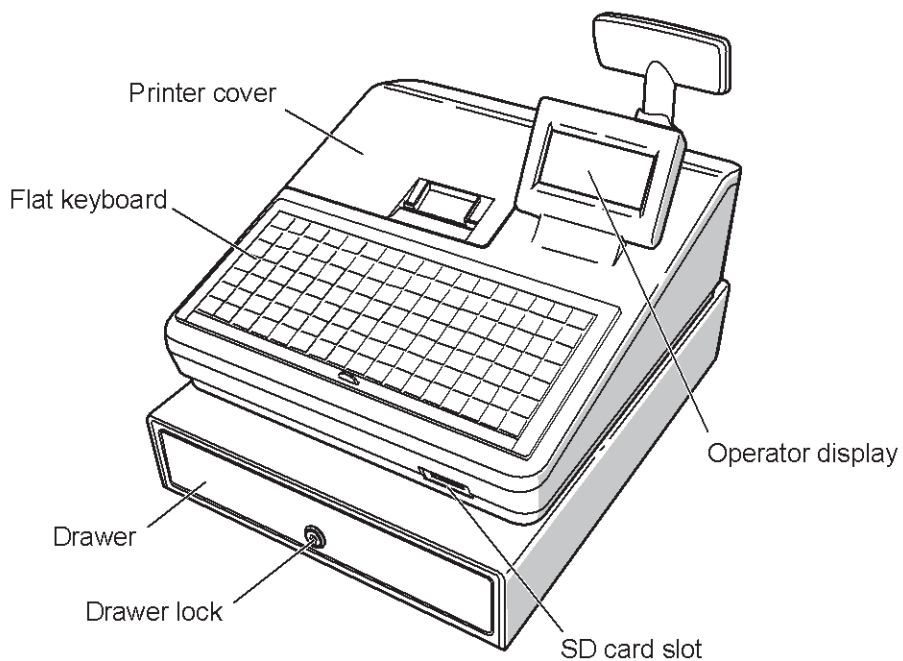

■ Rear view (XE-A207W/XE-A207B)
(XE-A217W/XE-A217B)

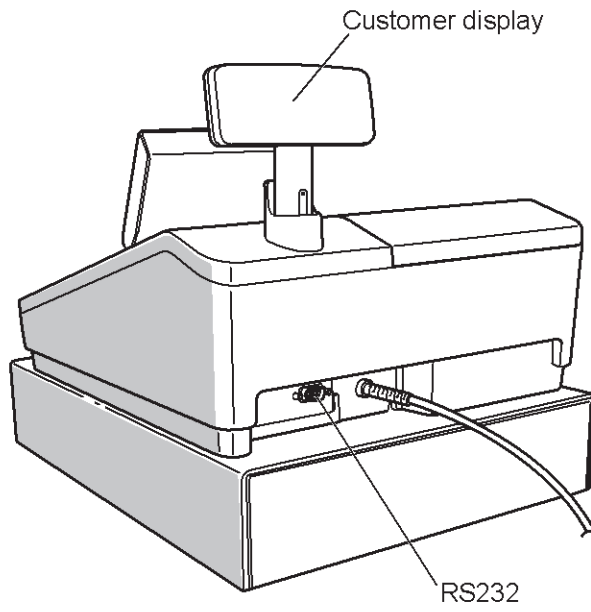

Printer

The printer is a receipt (one station) type thermal printer, and therefore it does not require any type of ink ribbon or cartridge. The average life of the printer is approximately 5 million lines.

When removing the printer cover, lift up its rear.

When installing the printer cover, hook it on the pawls on the cabinet and shut it.

Caution: The paper cutter is mounted on the printer cover. Be careful not to cut yourself.

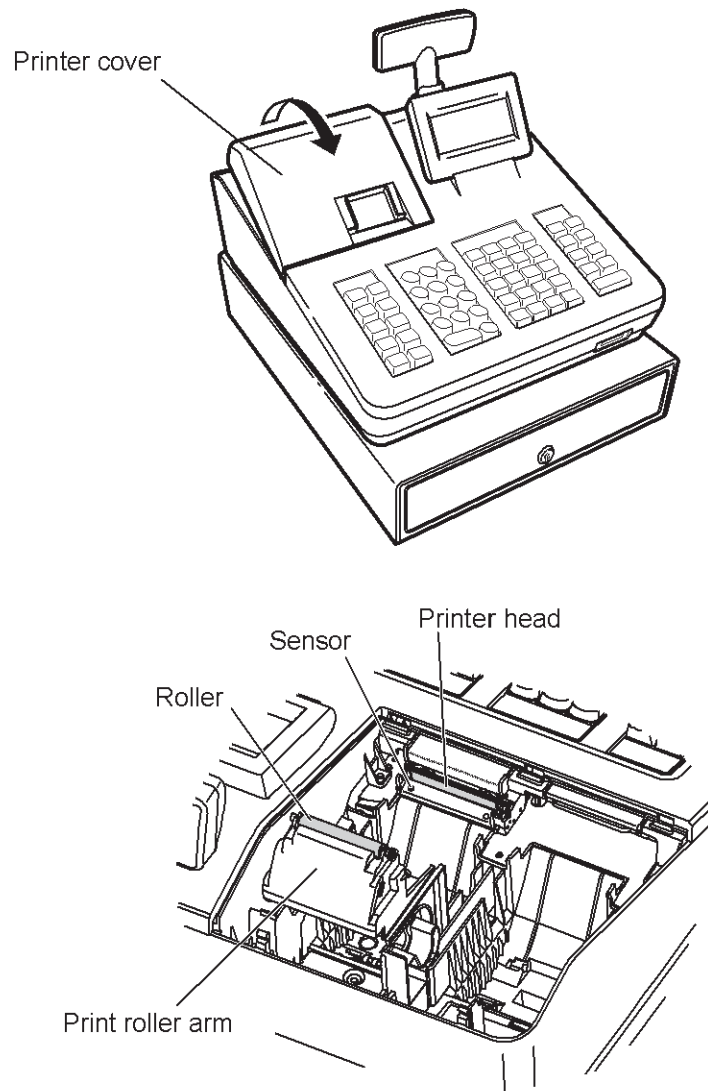

NOTE Do not attempt to remove the paper with the print roller arm in the hold position. This may result in damage to the printer and printer head.

Keyboard XE-A207W/XE-A207B

Keyboard layout



Function key list

| | | | |
|--|-----------------------------|--|--|
| | Receipt paper feed key | | Price lookup/Sub department key |
| | Electronic journal view key | | Department code entry key |
| | Function menu key | | Department shift key |
| | Auto menu key | | Clerk code entry key |
| | Paid out key | | Department 1-32 key |
| | Percent 1 key | | Cursor (up/down arrow) key |
| | Void key | | Mode key |
| | Refund key | | Escape/Cancel key |
| | Help key | | Credit 1 key |
| | Discount key | | Payment menu key |
| | Multiplication key | | Check 1 key |
| | Decimal point key | | Non-add code/Time display/Subtotal key |
| | Clear key | | Total/No sale key |
| | Numeric key | | |
| | | | |

* In this manual each department key is represented like in order to distinguish it from direct price lookup keys.

Keyboard XE-A217W/XE-A217B

































Keyboard layout

| | | | | | | | | | | | | | | | | |
|--------------|--------------|---|----------------|-----------------|------------|------|---|----|----|----|----|----|----|----|----|----|
| ↑ RECEIPT | HELP | ↑ | MODE | 2 | 4 | 6 | 7 | 14 | 21 | 28 | 35 | 42 | 49 | 56 | 63 | 70 |
| G.C. RCPT | EJ VIEW | ↓ | ESC/ CANCEL | 1 | 3 | 5 | 6 | 13 | 20 | 27 | 34 | 41 | 48 | 55 | 62 | 69 |
| FUNC MENU | AUTO MENU | ⊗ | • | CL | DEPT # | L3 | 5 | 12 | 19 | 26 | 33 | 40 | 47 | 54 | 61 | 68 |
| CLK # | PLU /SUB | 7 | 8 | 9 | CR1 | L2 | 4 | 11 | 18 | 25 | 32 | 39 | 46 | 53 | 60 | 67 |
| ⊖ | %1 | 4 | 5 | 6 | CH1 | L1 | 3 | 10 | 17 | 24 | 31 | 38 | 45 | 52 | 59 | 66 |
| PO | RF | 1 | 2 | 3 | #/TM ST | GLU | 2 | 9 | 16 | 23 | 30 | 37 | 44 | 51 | 58 | 65 |
| ∞ | VAT SHIFT | 0 | 00 | PAYMENT MENU | TL/NS | NBAL | 1 | 8 | 15 | 22 | 29 | 36 | 43 | 50 | 57 | 64 |

Programming keyboard layout

| | | | | | | | | | | | | | | | | | | |
|--------------|------|---|----------------|----------------|-------------------|------------------|---|---|---|---|---|---|---|---|---|---|---|---|
| ↑ RECEIPT | HELP | ↑ | MODE (HOME) | (PAGE UP) | | € | € | □ | + | - | { | } | \ | ~ | Ⓒ | À | Ô | |
| | | ↓ | ESC/ CANCEL | (PAGE DOWN) | | @ | & | * | - | % | < | > | , | ” | ; | : | ! | ¿ |
| | | ⊗ | • | CL | (PREV. RECORD) | (NEXT RECORD) | À | È | Ì | Ò | Ù | À | È | Ì | Ò | Ù | | |
| | | 7 | 8 | 9 | (DEL) | | á | é | í | ó | ú | à | è | ì | ò | ù | | |
| (←) | (→) | 4 | 5 | 6 | | | Q | W | E | R | T | Y | U | I | O | P | | |
| (CAPS) | | 1 | 2 | 3 | #/TM ST | | A | S | D | F | G | H | J | K | L | B | | |
| (SHIFT) | (DC) | 0 | 00 CODE | (SPACE) | TL/NS | | Z | X | C | V | B | N | M | À | Ç | Ñ | | |

■ Function key list

| | | | |
|---|---------------------------------|---|--|
|  | Receipt paper feed key |  | Department 1-6 key |
|  | Help key |  | Multiplication key |
|  | Guest check receipt key |  | Decimal point key |
|  | Electronic journal view key |  | Clear key |
|  | Function menu key |  | Numeric key |
|  | Auto menu key |  | |
|  | Clerk code entry key |  | Payment menu key |
|  | Price lookup/Sub department key |  | Department code entry key |
|  | Discount key |  | Credit 1 key |
|  | Percent 1 key |  | Check 1 key |
|  | Paid out key |  | PLU level shift 1 to 3 keys |
|  | Refund key |  | Non-add code/Time display/Subtotal key |
|  | Void key |  | Guest lookup key |
|  | Value added tax shift key |  | Total/No sale key |
|  | Cursor (up/down arrow) key |  | New balance key |
|  | Mode key |  | Direct PLU key |
|  | Escape/Cancel key | | |

* In this manual each department key is represented like  in order to distinguish it from direct PLU keys.

■ Inserting the keyboard sheet (XE-A217W/XE-A217B only)

Two types of keyboard sheets are installed on the cash register; one for ordinal use and one for text programming.

Insert the keyboard sheet between the keyboard cover and the cabinet as illustrated below.

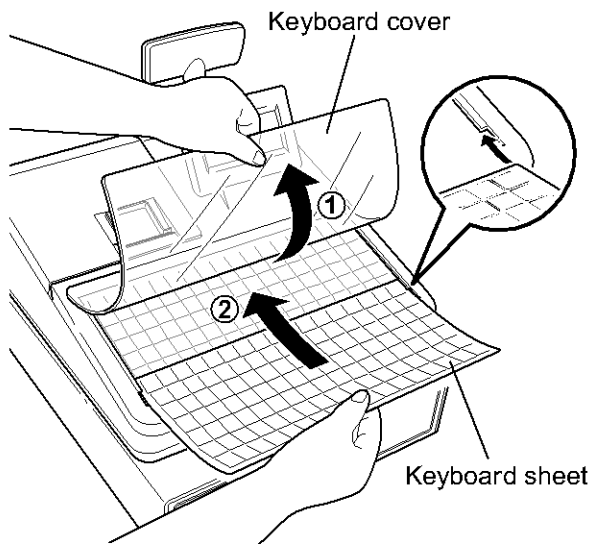

1. Turn over the keyboard cover.
2. Insert the keyboard sheet into the slit.
3. Close the keyboard cover.

NOTE

- Do not spread the keyboard cover too far as it might tear.
- Replace the keyboard sheet with a new one if by chance it gets wet. Use of a wet keyboard sheet may cause problems.
- Be sure to use only SHARP-supplied keyboard sheets. Thick or hard sheets make key operations difficult.
- Smooth the keyboard sheet evenly under the keyboard cover, without any folds or wrinkles, to ensure easier operation.
- If you require a new keyboard sheet, please contact your dealer.

RS232 Connector/SD Card Slot

■ RS232 connector

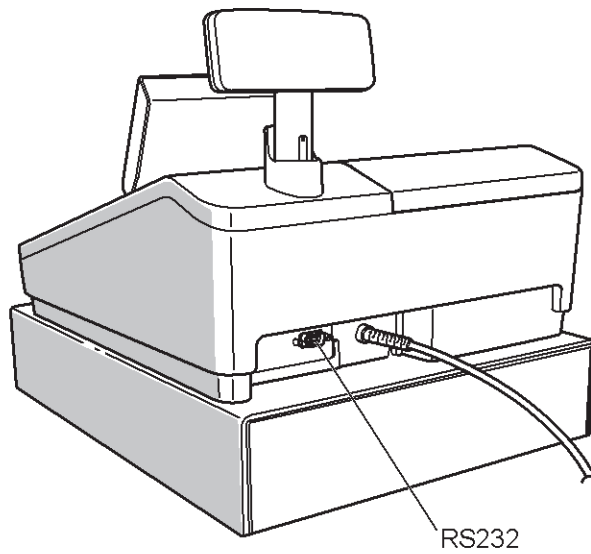

■ SD card slot

Refer to the "SD CARD Mode" section.

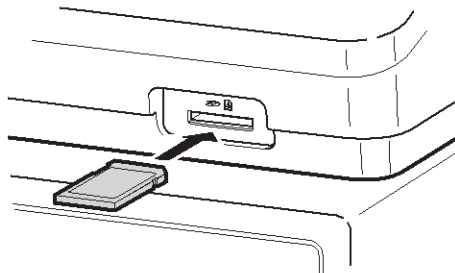

Displays

■ Operator display

• Screen example 1 (REG mode)

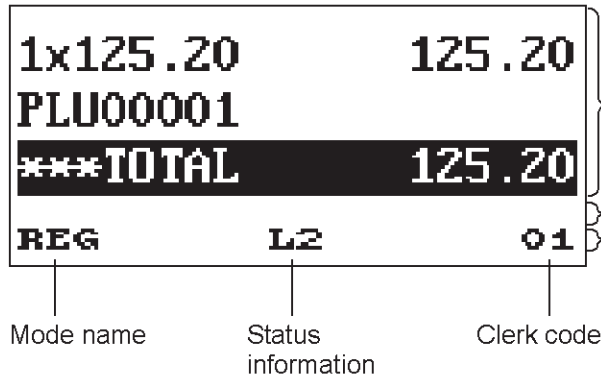

Sales information area:

When a transaction information occupies more than 2 lines, you can scroll to the direction by using the keys. Sales information you have just entered such as items and prices will appear between the 1st and the 2nd line. Total is always appear at the 3rd line.

Numeric Entry Area:

Status area:

- PLU level shift indicator (L2-L3) * : Shows the PLU level currently selected.
- Receipt ON/OFF status indicator (R) : Appears when the receipt ON-OFF function signs OFF.
- VAT shift status indicator (V) * : Appears when the VAT status is shifted.
- Electronic journal near full indicator (▣) : Appears (▣) when the used memory is 80%.
: Appears (▣) when the used memory is 90%.
: Appears (▣) when the used memory is 95%.
- Sentinel mark (X) : Appears when the cash in drawer exceeds a programmed sentinel amount. The sentinel check is performed for the total cash in drawer.

* XE-A217W/XE-A217B only

• Screen example 2 (PGM mode)

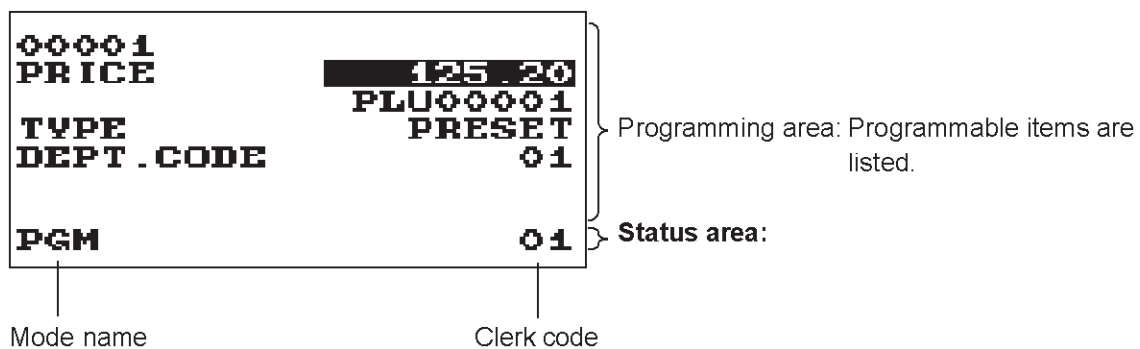

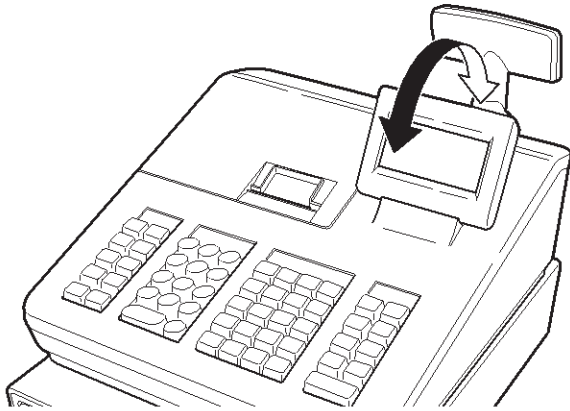

The display can be tilted back and forth to the best operational viewing angle.

NOTE

Do not try to force the display beyond its full position.

■ **Customer display**



■ **Screen save mode**

When you want to save the electric power or save the display's life, use the screen save function. This function can turn off the display and the LCD backlight when any clerk does not operate the register for an extended period of time. You can program the time for which your register should keep the normal status (in which the backlight is "ON") before it goes into the screen save mode.

This machine will enter the screen save mode two minutes later by default.

To go back to the normal mode, press any key.

The backlight in display is a consumable part.

When the LCD display may no longer be adjusted and become darker, you should replace the LCD unit.

Consult your authorized SHARP dealer for further details.

2

Selecting an Operating Mode

When you turn the register on and press the **[MODE]** key, the mode selection window will appear on the display, listing available operating modes as shown below.

Mode selection window

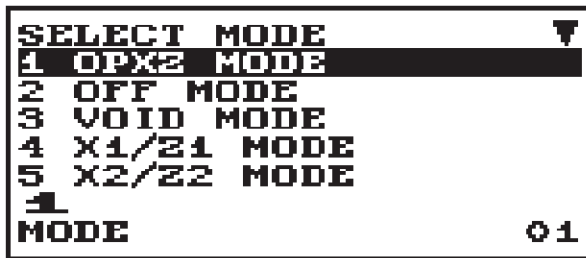

Operating Modes

You can select any mode other than REG from the list in the mode selection window. Your register supports the following operating modes:

| | |
|--------------|--|
| REG mode | This mode allows you to enter various sales information. The mode selection window does not list this mode. To select this mode from the mode selection window, press the [ESC/CANCEL] key. |
| OPXZ mode | This mode allows clerks to take X or Z reports on their sales information. |
| OFF mode | This mode locks all the operations of the register. When you select this mode, the window will disappear. Pressing any key turns the register ON. |
| VOID mode: | This mode allows correction after finalizing a transaction. |
| X1/Z1 mode | This mode is used to take various daily total reports (X1/Z1 reports). |
| X2/Z2 mode | This mode is used to take various weekly or monthly reports (X2/Z2 reports). |
| PGM mode | This mode is used to program various items. |
| SD CARD mode | This mode allows you to save and load the data of your register to and from an SD card. |

Mode Selection

Procedure

Press the **MODE** key. The following mode screen is displayed.

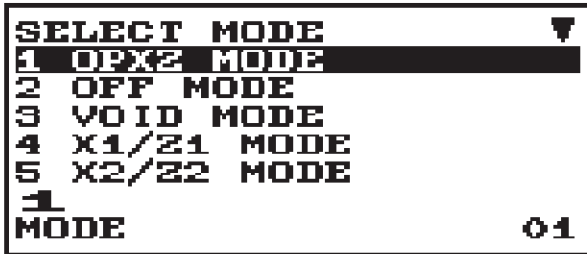

Use one of the following ways:

- Move the cursor to the desired option by using the **↑** or **↓** key, and press the **TL/NS** key.
- Enter the desired option number by using a numeric key and press the **TL/NS** key.

NOTE When you want to enter the REG mode, simply press the **ESC/CANCEL** key.

3

Prior to Making Entries

Preparations for Entries

■ Receipt paper roll

If the receipt paper roll is not set in the machine or it is getting low, install a new one according to section "Replacing the Paper Roll" under "Operator Maintenance."

■ Receipt ON/OFF function

You can disable receipt printing in the REG mode to save paper using the receipt function. Press the **FUNC MENU** key. Select "3 RECEIPT SW" and press the **TL/NS** key for XE-A217. For XE-A207, select "4 RECEIPT SW" and press the **TL/NS** key. Select "OFF" to disable receipt printing. When the function is in the OFF status, the receipt off indicator "R" is highlighted.

NOTE Your register will print reports regardless of the receipt state. This means that the receipt roll must be installed even when the receipt state is "OFF".

■ Clerk assignment

Prior to any item entries, a clerk must enter his/her clerk codes into the register.

To sign on:

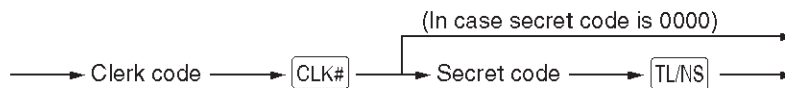

To sign off:



Error Warning

In the following examples, your register will go into an error state accompanied with a warning beep and the error message on the display. Clear the error state by pressing the **CL** key and then take the proper action to remedy the problem.

- When you exceed a 32-digit number (entry limit overflow):
Cancel the entry and reenter a correct number.
- When you make an error in key operation:
Clear the error and try the entry again.
- When you make an entry beyond a programmed amount entry limit:
Check to see if the entered amount is correct. If it is correct, it can be rung up in the MGR mode.
Contact your manager.
- When an including-tax subtotal exceeds eight digits:
Clear the error message by pressing the **CL** key and then press a media key to finalize the transaction.

Error escape function

To quit a transaction due to an error or an unforeseen event, use the error escape function as shown below:

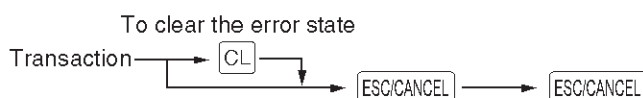

The transaction is voided (treated as a subtotal void) and the receipt is issued by this function. If you have already entered a tendered amount, the operation is finalized as a cash sale.

Item Selection from the Menu

Your register allows you to select functions from a menu. There are three menus available from the key selection on the keyboard; **FUNC MENU**, **PAYMENT MENU** and **AUTO MENU**. Each menu can be opened as follows:

• AUTO MENU

```

AUTO MENU
1 AUTO 1
2 AUTO 2
3 AUTO 3
4 AUTO 4
5 AUTO 5
REG                                01
    
```

• FUNCTION MENU

```

XE-A207W/XE-A207B
FUNCTION MENU
1 G.C. RCPT
2 ***RA
3 /Z
***TOTAL 0.00
REG                                01
    
```

• PAYMENT MENU

```

PAYMENT MENU
1 CHECK#2
2 CREDIT2
3 EXCH1
***TOTAL 0.00
REG                                01
    
```

```

XE-A217W/XE-A217B
FUNCTION MENU
1 ***RA
2 /Z
3 RECEIPT SW
***TOTAL 0.00
REG                                01
    
```

Procedure

In the REG mode, press **FUNC MENU**, **PAYMENT MENU** or **AUTO MENU** key. The corresponding menu list appears.

Starting Cash Memory Entry

If you enter the amount of currency for the starting amount in the drawer before entry operations, you can separate that amount from the sales amount when reports are generated.

Your register can be programmed to enforce the entry of starting cash into memory.

Procedure

1. Press the **MODE** key.
2. Select the "1 OPXZ MODE" and press the **TL/NS** key.
3. Select the desired option "3 SCM(+)" or "4 SCM(-)" by using the **↓** key and press the **TL/NS** key.

```

SCM(+ )
AMOUNT  0.00
OPXZ                                01
    
```

Enter the amount for domestic currency by using the **TL/NS** key.

```

CLK#01  CLERK01
SCM(+ )  *0.00
SCM TTL  *100.00
    
```

HELP FUNCTION

The help function allows you to print guidance messages for basic programming procedures of the cash register.

■ Printing the help menu

Press the **[HELP]** key to print the help menu. This menu provides a list of the programming procedures for which you can print the guidance messages.

| Example | Key operation | Print |
|---------|---------------|--|
| | [HELP] | <pre> HELP MENU 1 HOW TO SET THE PAPER 2 EJ VIEW 3 DATE SETTING 4 TIME SETTING 5 VAT RATE SETTING 6 VAT TEXT SETTING 7 VAT ASSIGNMENT TO DEPT. 8 DEPARTMENT TEXT SETTING 9 MINUS DEPARTMENT SETTING 10 PLU TO DEPT. ASSIGNMENT 11 PLU TEXT SETTING 12 PLU PRICE SETTING 13 LOGO MESSAGE SETTING 14 REPORT PRINT 15 HOW TO SIGN ON A CLERK 16 HOW TO SET RCPT SW OFF/ON 17 HOW TO FORMAT SD CARD TO PRINT ABOVE EACH HELP CONTENTS, EX) 1[HELP]. </pre> |

■ Printing guidance messages

By reference to the help menu above, press the corresponding numeric key and then the **[HELP]** key to print the guidance message for each programming procedure.

| Example | Key operation | Print |
|---------|-----------------|--|
| | 4 [HELP] | <pre> 4 TIME SETTING Mode selection: PGM MODE Select "2 SETTING". Select "7 DATE/TIME". Push [↓] key to skip DATE. EX) PM 4:30 (TIME FORMAT=24 HOUR) 1630[TL/NS] </pre> |

Sample print of TIME SETTING

4 Entries

Item Entries

In this manual, the key description is given basically with the model XE-A217. For those with XE-A207, refer to the Function key list on page 11.

Single item entries

Department entries (direct department entries)

Enter a unit price and press a department key. If you use a programmed unit price, press a department key only.

Procedure

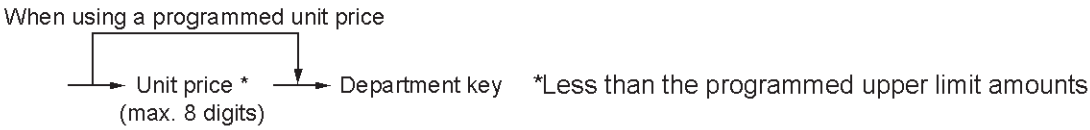

- NOTE**
- For XE-A207W/XE-A207B, when using the department key 17 to 32, you need to press the **DEPT SHIFT** key before pressing the department key.
 - When those departments for which the unit price has been programmed as zero (0) are entered, only the sales quantity is added.

Department entries (indirect department entries)

The register provides a maximum of 99 departments for a merchandise classification. Group attributes, such as taxable status, are applied to items when they are entered to the departments.

Procedure

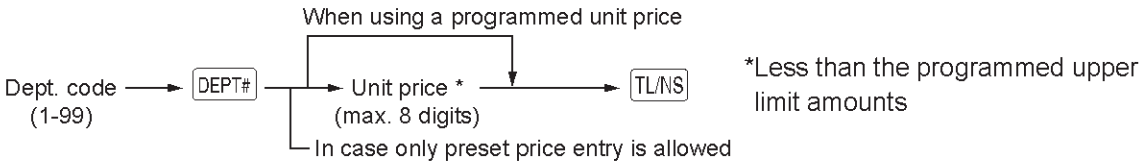

- NOTE**
- You can directly enter the code No. of the department using the numeric key. For the code No. exceeding the figure on the numerical key board (33 and above for XE-A207W/XE-A207B, 7 and above for XE-A217W/XE-A217B), use this function.

Example

| Key operation | Print |
|---------------|------------------------|
| 1200 [6] | 1x 12.00 *12.00 |
| [5] | DPT.06 |
| 3 [DEPT#] | 1x 7.10 *7.10 |
| 520 | DPT.05 |
| [TL/NS] | 1x 5.20 *5.20 |
| [4] | DPT.03 |
| [TL/NS] | 1x 6.80 *6.80 |
| | DPT.04 |
| | CASH *31.10 |

PLU entries (indirect PLU entries)

Enter a PLU code and press the [PLU/SUB] key. If you do not use a programmed unit price, you need to enter a unit price after pressing the [PLU/SUB] key.

Procedure

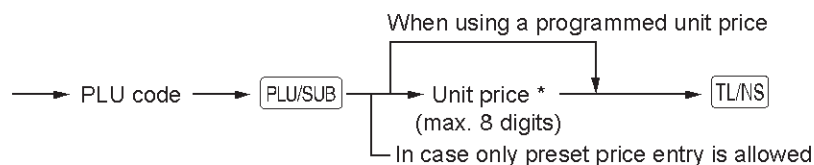

NOTE When those PLUs for which the unit price has been programmed as zero (0) are entered, only the sales quantity is added.

PLU entries (direct PLU entries) (For XE-A217W/XE-A217B only)

Enter the assigned PLU code using the direct PLU keys provided in the keyboard. Here you can simply press the assigned direct PLU keys. The price assigned to the selected PLU code is displayed on the screen.

The direct PLU keys are the numerical keys arranged on the right side of the keyboard and with numbers 1 to 70.

Procedure

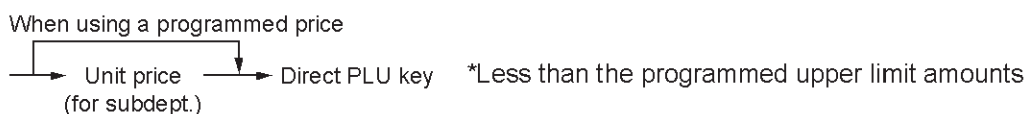

Example

| Key operation | Print |
|---------------|------------------------|
| 2 [PLU/SUB] | 1x 5.10 *5.10 |
| 16 [PLU/SUB] | PLU00002 |
| 1200 | 1x 12.00 *12.00 |
| [TL/NS] | PLU00016 |
| [8] | 1x 2.10 *2.10 |
| [TL/NS] | PLU00008 |
| | CASH *19.20 |

Repeat entries

The Repeat Entry function allows you to enter a sale of two or more of the same items. You can simply press the department key, **DEPT#**, or **PLU/SUB** key to repeat entry.

| Example | Key operation | Print |
|--------------------------------------|---|---|
| Repeated department entry (direct) | 200 <input type="text" value="2"/> <input type="text" value="2"/> <input type="text" value="2"/> 4 | 3x 2.00 *6.00 DPT. 02 |
| Repeated department entry (indirect) | <input type="text" value="DEPT#"/> 680 <input type="text" value="TL/NS"/> <input type="text" value="DEPT#"/> | 2x 6.80 *13.60 DPT. 04 |
| Repeated PLU entry (indirect) | 10 <input type="text" value="PLU/SUB"/> <input type="text" value="PLU/SUB"/> <input type="text" value="PLU/SUB"/> | 3x 5.10 *15.30 PLU00010 |
| Repeated PLU* entry (direct) | <input type="text" value="5"/> <input type="text" value="5"/> | 2x 6.50 *13.00 PLU00005 |
| Repeated subdepartment entry | 60 <input type="text" value="PLU/SUB"/> 500 <input type="text" value="TL/NS"/> <input type="text" value="PLU/SUB"/> <input type="text" value="TL/NS"/> | 2x 5.00 *10.00 PLU00060 |
| | | CASH *57.90 |

* XE-A217W/XE-A217B only

■ Multiplication entries

Use this feature when you need to enter two or more of the same items.

This feature helps you when you sell a large quantity of items or need to enter quantities that contain decimals.

Procedure

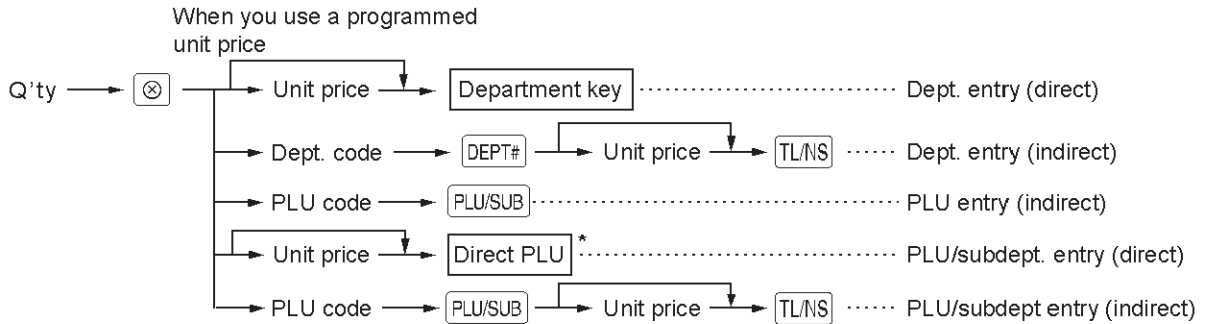

* XE-A217W/XE-A217B only

- Q'ty: Up to four-digit integer + three-digit decimal
- Unit price: Less than a programmed upper limit
- Q'ty x unit price: Up to eight digits

Example

| Key operation | Print |
|---------------|-------------------------|
| 7 5 ⊗ | 7.500x 1.65 *12.38 |
| 165 2 | DPT. 02 |
| 2 ⊗ | 2x 2.50 *5.00 |
| 5 DEPT# | DPT. 05 |
| 250 | 15x 1.20 *18.00 |
| TL/NS | PLU00008 |
| 15 ⊗ | 8.250x 1.50 *12.38 |
| 8 PLU/SUB | PLU00005 |
| 8 25 ⊗ | 3x 1.00 *3.00 |
| 5 | PLU00060 |
| 3 ⊗ | |
| 60 PLU/SUB | CASH *50.76 |
| 100 | |
| TL/NS | |
| TL/NS | |

■ Split-pricing entries

You will use this function when your customer wants to purchase more or less than the base quantity of a loose item.

Procedure

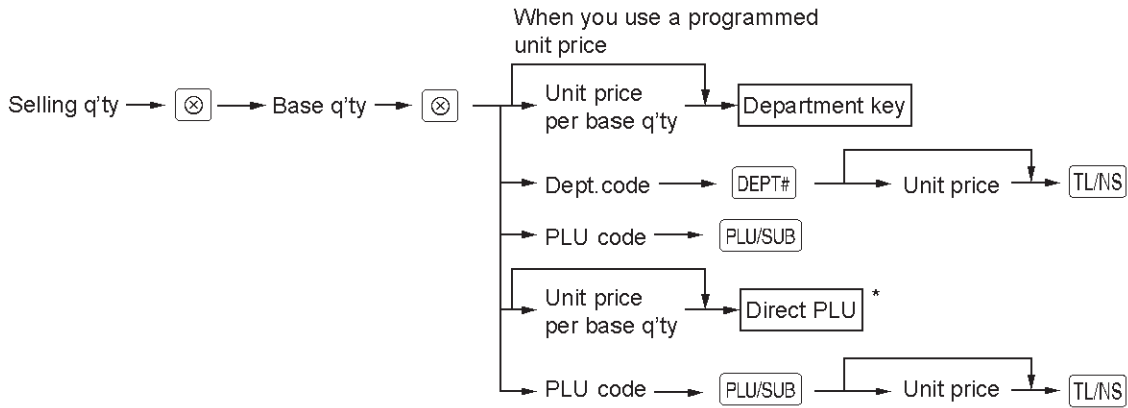

* XE-A217W/XE-A217B only

- Selling quantity: Up to four-digit integer + three-digit decimal
- Base quantity: Up to two digits (integer)

Example

| Key operation | Print |
|---------------|-------------|
| 7 ⊗ 10 ⊗ | 7x 10/ 6.00 |
| 600 2 | DPT.02 |
| 8 ⊗ 5 ⊗ | 8x 5/ 1.50 |
| 35 PLU/SUB | PLU00035 |
| TL/NS | CASH |
| | *6.60 |

■ Single item cash sale (SICS)

- This function is useful when a sale is for only one item and is for cash; such as a pack of cigarettes. This function is applicable only to those departments that have been set for SICS or to their associated PLUs.
- The transaction is finalized and the drawer opens as soon as you press the department key, **DEPT#** key, **PLU/SUB** key or the direct PLU key.

Example

| Key operation | Print |
|--|--|
| 250 For finishing → 3 the transaction | <pre> 1x 2.50 *2.50 DPT. 03 CASH *2.50 </pre> |

NOTE

If an entry to a department, PLU/subdepartment set for SICS follows the ones to departments, PLUs/subdepartments not set for SICS, it does not finalize and results in a normal sale.

■ PLU level shift (for direct PLUs) (for XE-A217W/XE-A217B only)

This shift can double or triple the number of direct PLUs on your register without pressing additional direct PLU keys. You can use direct PLUs in three levels by the PLU level shift keys **L1** through **L3**. Level key shifts the PLU level from the other two to the required level. (The normal level is the level 1.) You must program your machine in the PGM mode to select one of the two PLU level shift modes — automatic return mode* and lock shift mode** — and decide whether to allow PLU level shift in both the REG and MGR modes or in the MGR mode alone.

* The automatic return mode automatically shifts the PLU level back to level 1 after pressing a direct PLU key or finalizing each transaction.

** The lock shift mode holds the current PLU level until depression of a PLU level shift key.

Automatic return mode (for PLU levels)

If your register has been programmed for PLU level in the automatic return mode, press a desired PLU level shift key before a numeric entry.

Procedure

(Returning every item entry)

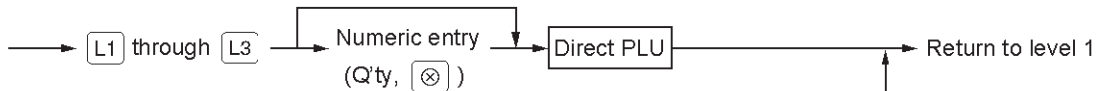

(Returning every transaction)

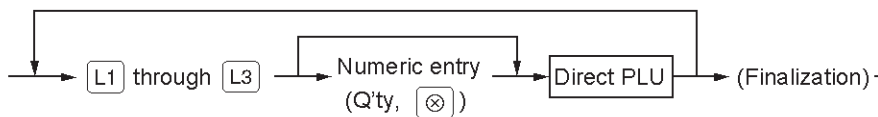

Lock shift mode (for PLU levels)

If your register has been programmed for PLU level in the lock shift mode, press a desired PLU level shift key before a numeric entry.

Procedure

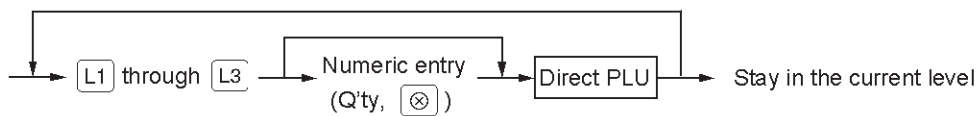

Example

Level 1 : PLU code 1, PLU code 2

Level 2 : PLU code 71, PLU code 72

- When your register has been programmed for the automatic return mode (by one item):

| Key operation | Print | | | | | | | | | | | | | | |
|---|---|---------|-------|----------|--|---------|-------|----------|--|---------|-------|----------|--|-------------|--------------|
| <div style="display: flex; flex-direction: column; align-items: center;"> <div style="margin-bottom: 5px;">1</div> <div style="margin-bottom: 5px;">L2 1</div> <div style="margin-bottom: 5px;">2</div> <div>TL/NS</div> </div> | <table border="1"> <tbody> <tr><td>1x 1.20</td><td>*1.20</td></tr> <tr><td>PLU00001</td><td></td></tr> <tr><td>1x 5.30</td><td>*5.30</td></tr> <tr><td>PLU00071</td><td></td></tr> <tr><td>1x 2.50</td><td>*2.50</td></tr> <tr><td>PLU00002</td><td></td></tr> <tr><td>CASH</td><td>*9.00</td></tr> </tbody> </table> | 1x 1.20 | *1.20 | PLU00001 | | 1x 5.30 | *5.30 | PLU00071 | | 1x 2.50 | *2.50 | PLU00002 | | CASH | *9.00 |
| 1x 1.20 | *1.20 | | | | | | | | | | | | | | |
| PLU00001 | | | | | | | | | | | | | | | |
| 1x 5.30 | *5.30 | | | | | | | | | | | | | | |
| PLU00071 | | | | | | | | | | | | | | | |
| 1x 2.50 | *2.50 | | | | | | | | | | | | | | |
| PLU00002 | | | | | | | | | | | | | | | |
| CASH | *9.00 | | | | | | | | | | | | | | |

Level 1 : PLU code 1, PLU code 2

Level 2 : PLU code 71, PLU code 72

- When your register has been programmed for the lock shift mode:

| Key operation | Print | | | | | | | | | | | | | | |
|--|--|---------|-------|----------|--|---------|-------|----------|--|---------|-------|----------|--|-------------|---------------|
| <div style="display: flex; flex-direction: column; align-items: center;"> <div style="margin-bottom: 5px;">L1 1</div> <div style="margin-bottom: 5px;">L2 1</div> <div style="margin-bottom: 5px;">2</div> <div>TL/NS</div> </div> | <table border="1"> <tbody> <tr><td>1x 1.20</td><td>*1.20</td></tr> <tr><td>PLU00001</td><td></td></tr> <tr><td>1x 5.30</td><td>*5.30</td></tr> <tr><td>PLU00071</td><td></td></tr> <tr><td>1x 6.10</td><td>*6.10</td></tr> <tr><td>PLU00072</td><td></td></tr> <tr><td>CASH</td><td>*12.60</td></tr> </tbody> </table> | 1x 1.20 | *1.20 | PLU00001 | | 1x 5.30 | *5.30 | PLU00071 | | 1x 6.10 | *6.10 | PLU00072 | | CASH | *12.60 |
| 1x 1.20 | *1.20 | | | | | | | | | | | | | | |
| PLU00001 | | | | | | | | | | | | | | | |
| 1x 5.30 | *5.30 | | | | | | | | | | | | | | |
| PLU00071 | | | | | | | | | | | | | | | |
| 1x 6.10 | *6.10 | | | | | | | | | | | | | | |
| PLU00072 | | | | | | | | | | | | | | | |
| CASH | *12.60 | | | | | | | | | | | | | | |

Display of Subtotals

Your register provides the following types of subtotals:

■ Subtotal

Press the #TM/ST key at any point during a transaction. The sales subtotal including tax will appear in the display.

Finalization of Transaction

■ Cash or check tendering

Press the **#/TM/ST** key to get an including-tax subtotal, enter the amount tendered by your customer, then press the **TL/NS** key if it is a cash tender or press the **CH1** key if it is a check tender. When the amount tendered is greater than the amount of the sale, your register will show the change due amount and the symbol "CHANGE." Otherwise your register will show the symbol "DUE" and a deficit. Make a correct tender entry.

Example

Cash tendering

| Key operation | Print |
|---|--|
| $\}$ #/TM/ST 1000 TL/NS | 1x 1.20 *1.20 PLU00001 1x 2.50 *2.50 PLU00002 ***TOTAL *3.70 CASH *10.00 CHANGE *6.30 |

Check tendering

| Key operation | Print |
|---|--|
| $\}$ #/TM/ST 1000 CH1 | 1x 1.20 *1.20 PLU00001 1x 2.50 *2.50 PLU00002 ***TOTAL *3.70 CHECK1 *10.00 CHANGE *6.30 |

NOTE

You can also enter a check tender from the PAYMENT menu window. Press the **PAYMENT MENU** key and select "1 CHECK 2" and enter the amount.

■ Mixed tendering (check + cash)

| Example | Key operation | Print |
|---------|---------------------------------------|--|
| | ? #/TM/ST 1000 CH1 500 TL/NS | <pre> 1x 5.10 *5.10 PLU00010 2x 4.80 *9.60 PLU00008 ***TOTAL *14.70 CHECK1 *10.00 CASH *5.00 CHANGE *0.30 </pre> |

■ Cash or check sale that does not need any tender entry

Enter items and press the **TL/NS** key if it is a cash sale or press the **CH1** key if it is a check sale. Your register will display the total sales amount.

| Example | Key operation | Print |
|---------|--------------------------|--|
| | 6 10 PLU/SUB TL/NS | <pre> 1x 3.00 *3.00 PLU00006 1x 7.15 *7.15 PLU00010 CASH *10.15 </pre> |
| | | In the case of check sale |
| | | <pre> 1x 3.00 *3.00 PLU00006 1x 7.15 *7.15 PLU00010 CHECK1 *10.15 </pre> |

■ Credit sale

Enter items and press the **CR1** key.

| Example | Key operation | Print | | | | | | | | | | | | |
|----------|--|---|---------|-------|----------|--|---------|-------|----------|--|------|--|---------|--------------|
| | <div style="display: flex; flex-direction: column; align-items: center; gap: 5px;"> <div style="border: 1px solid black; padding: 2px 5px;">6</div> <div style="border: 1px solid black; padding: 2px 5px;">7</div> <div style="border: 1px solid black; padding: 2px 5px;">#/TM/ST</div> <div style="border: 1px solid black; padding: 2px 5px;">CR1</div> </div> | <table style="width: 100%; border-collapse: collapse;"> <tr> <td style="width: 60%;">1x 3.00</td> <td style="text-align: right;">*3.00</td> </tr> <tr> <td>PLU00006</td> <td></td> </tr> <tr> <td>1x 6.00</td> <td style="text-align: right;">*6.00</td> </tr> <tr> <td>PLU00007</td> <td></td> </tr> <tr> <td> </td> <td></td> </tr> <tr> <td>CREDIT1</td> <td style="text-align: right;">*9.00</td> </tr> </table> | 1x 3.00 | *3.00 | PLU00006 | | 1x 6.00 | *6.00 | PLU00007 | | | | CREDIT1 | *9.00 |
| 1x 3.00 | *3.00 | | | | | | | | | | | | | |
| PLU00006 | | | | | | | | | | | | | | |
| 1x 6.00 | *6.00 | | | | | | | | | | | | | |
| PLU00007 | | | | | | | | | | | | | | |
| | | | | | | | | | | | | | | |
| CREDIT1 | *9.00 | | | | | | | | | | | | | |

- NOTE**
- Amount tendering operations (i.e. change calculations) can be achieved by the **CR1** key when a PGM mode programming allows them.
 - You can also enter a credit tender from the PAYMENT menu window. Press the **PAYMENT MENU** key and select "2 CREDIT 2" and enter the amount.

■ Mixed-tender sale (cash or check tendering + credit tendering)

| Example | Key operation | Print | | | | | | | | | | | | | | | | | | | | |
|----------|---|---|---------|-------|----------|--|---------|-------|----------|--|---------|-------|----------|--|------|--|----------|---------------|------|-------|---------|-------|
| | <div style="display: flex; flex-direction: column; align-items: center; gap: 5px;"> <div style="font-size: 2em;">}</div> <div style="border: 1px solid black; padding: 2px 5px;">#/TM/ST</div> <div style="display: flex; align-items: center; gap: 5px;"> 950 <div style="border: 1px solid black; padding: 2px 5px;">TL/NS</div> </div> <div style="border: 1px solid black; padding: 2px 5px;">CR1</div> </div> | <table style="width: 100%; border-collapse: collapse;"> <tr> <td style="width: 60%;">1x 1.20</td> <td style="text-align: right;">*1.20</td> </tr> <tr> <td>PLU00001</td> <td></td> </tr> <tr> <td>1x 2.50</td> <td style="text-align: right;">*2.50</td> </tr> <tr> <td>PLU00002</td> <td></td> </tr> <tr> <td>3x 3.00</td> <td style="text-align: right;">*9.00</td> </tr> <tr> <td>PLU00003</td> <td></td> </tr> <tr> <td> </td> <td></td> </tr> <tr> <td>***TOTAL</td> <td style="text-align: right;">*12.70</td> </tr> <tr> <td>CASH</td> <td style="text-align: right;">*9.50</td> </tr> <tr> <td>CREDIT1</td> <td style="text-align: right;">*3.20</td> </tr> </table> | 1x 1.20 | *1.20 | PLU00001 | | 1x 2.50 | *2.50 | PLU00002 | | 3x 3.00 | *9.00 | PLU00003 | | | | ***TOTAL | *12.70 | CASH | *9.50 | CREDIT1 | *3.20 |
| 1x 1.20 | *1.20 | | | | | | | | | | | | | | | | | | | | | |
| PLU00001 | | | | | | | | | | | | | | | | | | | | | | |
| 1x 2.50 | *2.50 | | | | | | | | | | | | | | | | | | | | | |
| PLU00002 | | | | | | | | | | | | | | | | | | | | | | |
| 3x 3.00 | *9.00 | | | | | | | | | | | | | | | | | | | | | |
| PLU00003 | | | | | | | | | | | | | | | | | | | | | | |
| | | | | | | | | | | | | | | | | | | | | | | |
| ***TOTAL | *12.70 | | | | | | | | | | | | | | | | | | | | | |
| CASH | *9.50 | | | | | | | | | | | | | | | | | | | | | |
| CREDIT1 | *3.20 | | | | | | | | | | | | | | | | | | | | | |

- NOTE** Press the **CH1** key in place of the **TL/NS** key when your customer makes payment by checks.

Computation of VAT (Value Added Tax)/Tax

■ VAT/tax system

The cash register may be programmed for the following six VAT/tax systems. The cash register is pre-programmed as automatic VAT 1-4 system.

Automatic VAT 1 through 4 system (Automatic operation method using programmed percentages)

This system, at settlement, calculates VAT for taxable 1, taxable 2, taxable 3, and taxable 4 subtotals by using the corresponding programmed percentages.

Automatic tax 1 through 4 system (Automatic operation method using programmed percentages)

This system, at settlement, calculates taxes for taxable 1, taxable 2, taxable 3, and taxable 4 subtotals by using the corresponding programmed percentages, and also adds the calculated taxes to those subtotals, respectively.

Manual VAT 1 through 4 system (Manual entry method using programmed percentages)

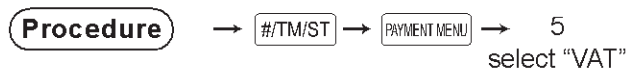

This system provides the VAT calculation for taxable 1, taxable 2, taxable 3, and taxable 4 subtotals. This calculation is performed using the corresponding programmed percentages when "VAT" from the payment menu is selected just after the key.

Manual VAT 1 system (Manual entry method for subtotals that uses VAT 1 preset percentages)



This system enables the VAT calculation for the subtotal. This calculation is performed using the VAT 1 preset percentages when "VAT" from the payment menu is selected just after the key. For this system, the keyed-in tax rate can be used.

Manual tax 1 through 4 system (Manual entry method using programmed percentages)

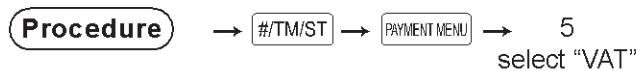

This system provides the tax calculation for taxable 1, taxable 2, taxable 3, and taxable 4 subtotals. This calculation is performed using the corresponding programmed percentages when "VAT" from the payment menu is selected just after the key. After this calculation, you must finalize the transaction.

Automatic VAT 1 and tax 2 through 4

This system enables the calculation in the combination with automatic VAT 1 and tax 2 through 4. This combination can be any of VAT 1 and tax 2 through 4. The tax amount is calculated automatically with the percentages previously programmed for these taxes.

NOTE

VAT/tax assignment is printed at the fixed right position of the amount on the receipt and bill as follows:

VAT1/tax1 —————> A
 VAT2/tax2 —————> B
 VAT3/tax3 —————> C
 VAT4/tax4 —————> D

When the multiple VAT/tax is assigned to a department or a PLU, a smaller number of the VAT/tax will be printed.

Example**Key operation**

(When the manual
 VAT 1 through 4
 system is selected)

8
 #/TM/ST
 PAYMENT MENU
 5
 TL/NS

Print

| | |
|-------------|--------------|
| 1x 9.60 | *9.60 |
| PLU00008 | |
| SUBTOTAL | *9.60 |
| ----- | |
| TAX1 ST | *9.60 |
| VAT 1 | *0.28 |
| NET 1 | *9.32 |
| ----- | |
| CASH | *9.60 |

■ VAT shift entries (for XE-A217W/XE-A217B only)

This feature is intended to shift the tax status of a particular department (or PLU) programmed for taxable 1 or taxable 1 and taxable 3.

1. When the VAT shift entry is made for a particular department or PLU programmed for taxable 1, their tax status shifts to taxable 2.
2. When this entry is made for a particular department (or PLU) programmed for taxable 1 and taxable 3, the tax status "taxable 1" remains unchanged, but the other, "taxable 3" is ignored.

Example**Key operation**

(When the Auto VAT 1
 through 4 system is
 selected)

1
 VAT SHIFT
 1
 TL/NS

Print

| | |
|-------------|--------------|
| 1x 1.20 | *1.20 |
| PLU00001 | |
| 1x 1.20 | *1.20 |
| PLU00001 | |
| SUBTOTAL | *2.40 |
| ----- | |
| TAX1 ST | *1.20 |
| VAT 1 | *0.06 |
| NET 1 | *1.14 |
| TAX2 ST | *1.20 |
| VAT 2 | *0.11 |
| NET 2 | *1.09 |
| ----- | |
| CASH | *2.40 |

Guest Check

■ Guest look up (GLU) system (for XE-A217W/XE-A217B only)

New guest

Procedure

For automatic GLU code generation

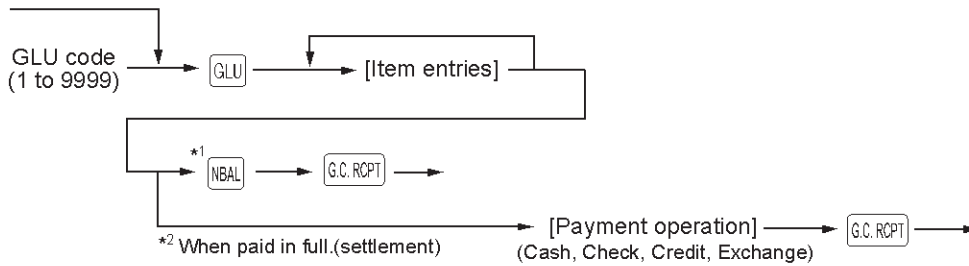

NOTE

- A clerk must have been registered before starting GLU entry.
- The GLU code refers to a code that will be used whenever the guest check must be accessed for re-ordering or final payment.

*1 The tax is not calculated.

*2 The tax is calculated and is added to the tax totalizer.

Example

Key operation

1001

Print

| | |
|----------|-------|
| GLU#1001 | |
| ***PBAL | *0.00 |
| 1x 1.20 | *1.20 |
| PLU00001 | |
| 1x 2.50 | *2.50 |
| PLU00002 | |
| ***NBAL | *3.70 |

Additional ordering

Procedure

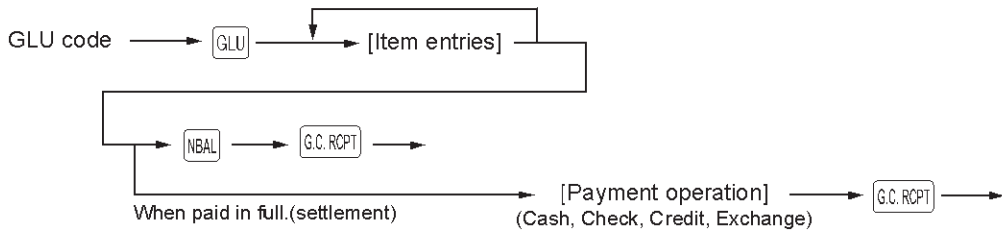

Example

Key operation

1001

Print

| | |
|---------------|--------------|
| GLU#1001 | |
| *BILL* | |
| 1x 1.20 | *1.20 |
| PLU00001 | |
| 1x 2.50 | *2.50 |
| PLU00002 | |
| 1x 6.00 | *6.00 |
| PLU00007 | |
| CASH | *9.70 |

■ Table bill copy print (for XE-A217W/XE-A217B only)

This function is used for issuing a table bill copy to the guest.

Procedure



Example

Key operation

Print

| | |
|---------------|--------------|
| *COPY* | |
| *BILL* | |
| 1x 1.20 | *1.20 |
| PLU00001 | |
| 1x 2.50 | *2.50 |
| PLU00002 | |
| 1x 6.00 | *6.00 |
| PLU00007 | |
| CASH | *9.70 |

Auxiliary Entries

■ Percent calculations (premium or discount)

- Your register provides percent calculations for a subtotal or each item entry depending on the programming.
- Percentage: 0.01 to 100.00%

Percent calculation for a subtotal

Example

| Key operation | Print | | | | | | | | | | | | | | | | | | | | | |
|--|--|---------------|--|-------|----------|--|--|---------|--|--------|----------|--|--|----------|--|--------|----|---------|-------|-------------|--|---------------|
| (When a discount of 10% is programmed for the <input type="text" value="%1"/> key.) | | | | | | | | | | | | | | | | | | | | | | |
| <input type="text" value="3"/> <input type="text" value="2"/> <input checked="" type="checkbox"/> <input type="text" value="5"/> | | | | | | | | | | | | | | | | | | | | | | |
| <input type="text" value="#/TM/ST"/> <input type="text" value="%1"/> | | | | | | | | | | | | | | | | | | | | | | |
| <input type="text" value="TL/NS"/> | | | | | | | | | | | | | | | | | | | | | | |
| | <table border="1"> <tbody> <tr> <td>1x 3.00</td> <td></td> <td>*3.00</td> </tr> <tr> <td>PLU00003</td> <td></td> <td></td> </tr> <tr> <td>2x 6.50</td> <td></td> <td>*13.00</td> </tr> <tr> <td>PLU00005</td> <td></td> <td></td> </tr> <tr> <td>SUBTOTAL</td> <td></td> <td>*16.00</td> </tr> <tr> <td>%1</td> <td>-10.00%</td> <td>-1.60</td> </tr> <tr> <td>CASH</td> <td></td> <td>*14.40</td> </tr> </tbody> </table> | 1x 3.00 | | *3.00 | PLU00003 | | | 2x 6.50 | | *13.00 | PLU00005 | | | SUBTOTAL | | *16.00 | %1 | -10.00% | -1.60 | CASH | | *14.40 |
| 1x 3.00 | | *3.00 | | | | | | | | | | | | | | | | | | | | |
| PLU00003 | | | | | | | | | | | | | | | | | | | | | | |
| 2x 6.50 | | *13.00 | | | | | | | | | | | | | | | | | | | | |
| PLU00005 | | | | | | | | | | | | | | | | | | | | | | |
| SUBTOTAL | | *16.00 | | | | | | | | | | | | | | | | | | | | |
| %1 | -10.00% | -1.60 | | | | | | | | | | | | | | | | | | | | |
| CASH | | *14.40 | | | | | | | | | | | | | | | | | | | | |

Percent calculation for item entries

Example

| Key operation | Print | | | | | | | | | | | | | | | | | | | | | |
|---|--|---------------|--|-------|----------|--|--|----|--------|-------|---------|--|-------|----------|--|--|----|-------|-------|-------------|--|---------------|
| (When a premium of 15% is programmed for the <input type="text" value="%1"/> key.) | | | | | | | | | | | | | | | | | | | | | | |
| <input type="text" value="6"/> <input type="text" value="30"/> <input type="text" value="PLU/SUB"/> | | | | | | | | | | | | | | | | | | | | | | |
| <input type="text" value="7"/> <input type="text" value="5"/> <input type="text" value="%1"/> | | | | | | | | | | | | | | | | | | | | | | |
| <input type="text" value="TL/NS"/> | | | | | | | | | | | | | | | | | | | | | | |
| | <table border="1"> <tbody> <tr> <td>1x 8.00</td> <td></td> <td>*8.00</td> </tr> <tr> <td>PLU00006</td> <td></td> <td></td> </tr> <tr> <td>%1</td> <td>15.00%</td> <td>*1.20</td> </tr> <tr> <td>1x 5.00</td> <td></td> <td>*5.00</td> </tr> <tr> <td>PLU00030</td> <td></td> <td></td> </tr> <tr> <td>%1</td> <td>7.50%</td> <td>*0.38</td> </tr> <tr> <td>CASH</td> <td></td> <td>*14.58</td> </tr> </tbody> </table> | 1x 8.00 | | *8.00 | PLU00006 | | | %1 | 15.00% | *1.20 | 1x 5.00 | | *5.00 | PLU00030 | | | %1 | 7.50% | *0.38 | CASH | | *14.58 |
| 1x 8.00 | | *8.00 | | | | | | | | | | | | | | | | | | | | |
| PLU00006 | | | | | | | | | | | | | | | | | | | | | | |
| %1 | 15.00% | *1.20 | | | | | | | | | | | | | | | | | | | | |
| 1x 5.00 | | *5.00 | | | | | | | | | | | | | | | | | | | | |
| PLU00030 | | | | | | | | | | | | | | | | | | | | | | |
| %1 | 7.50% | *0.38 | | | | | | | | | | | | | | | | | | | | |
| CASH | | *14.58 | | | | | | | | | | | | | | | | | | | | |

NOTE

- You can also enter a percent calculation from the function menu window. Press the key and select "2 %2" for XE-A217 and enter a percent calculation. For XE-A207, select "3 %2" and enter a percent calculation.
- Availability of item % and/or subtotal % depends on the programming data of %1 and %2.

■ Discount entries

Your register allows you to deduct a certain amount less than a programmed upper limit after the entry of an item or the computation of a subtotal depending on the programming.

Discount for a subtotal

Example

| Key operation | Print |
|---|-----------------------------------|
| 6 | |
| 60 <input type="button" value="PLU/SUB"/> | 1x 5.75 *5.75 |
| <input type="button" value="#/TM/ST"/> | PLU00006 |
| 100 <input type="button" value="⊖"/> | 1x 12.00 *12.00 |
| <input type="button" value="TL/NS"/> | PLU00060 |
| | SUBTOTAL *17.75 |
| | (-) -1.00 |
| | CASH *16.75 |

Discount for item entries

Example

| Key operation | Print |
|--|----------------------------------|
| 7 <input type="button" value="PLU/SUB"/> | |
| 75 <input type="button" value="⊖"/> | 1x 6.00 *6.00 |
| <input type="button" value="TL/NS"/> | PLU00007 |
| | (-) -0.75 |
| | CASH *5.25 |

■ Refund entries

For a refund entry, press the key just before you press a department key, key, direct PLU key (XE-A217W/XE-A217B only) or key. The operation before pressing the key is the same as the one of normal operation.

For example, if a refund item is the one entered into a department, enter the amount of the refund, then press the key and the corresponding department key in this order; if an item entered into a PLU is returned, enter the corresponding PLU code, then press the and keys.

Example

| Key operation | Print |
|--|---------------------------------|
| <input type="button" value="RF"/> 3 | |
| 7 <input type="button" value="⊗"/> | -1x 3.00 R-3.00 |
| 7 <input type="button" value="RF"/> <input type="button" value="PLU/SUB"/> | PLU00003 |
| <input type="button" value="TL/NS"/> | -7x 6.00 R-42.00 |
| | PLU00007 |
| | CHANGE *45.00 |

■ Printing of non-add code numbers

Enter a non-add code number such as a guest code number within a maximum of 16 digits and press the **#/TM/ST** key at any point during the entry of a sale. The non-add code is printed on the receipt.

Example

| Key operation | Print |
|---------------------|-------------------|
| 1230 #/TM/ST | #0000000000001230 |
| 700 1 | 1x 7.00 *7.00 |
| CR1 | DPT.01 |
| | CREDIT1 *7.00 |

Payment Treatment

■ Currency exchange

Your register allows payment entries in foreign currency. Press the **PAYMENT MENU** key, and select either option of EXCH1 or EXCH2 to create a subtotal in foreign currency.

Procedure

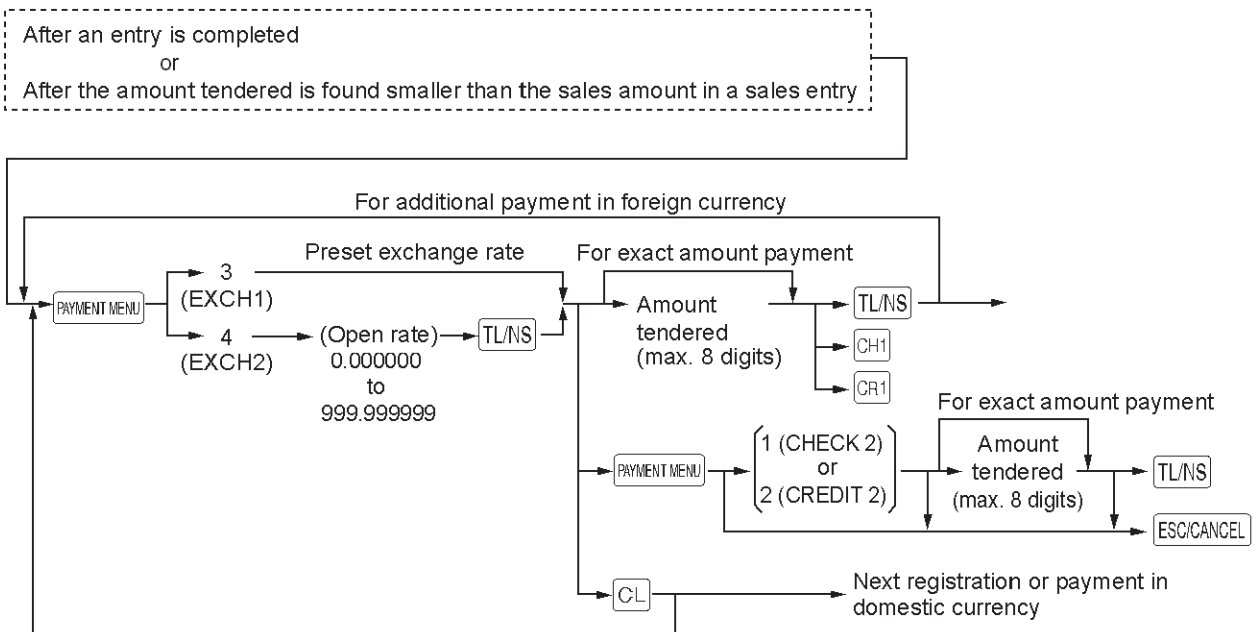

NOTE

- When the amount tendered is short, its equivalent in deficit is shown in domestic currency.
- Change amount will be displayed in domestic currency.
- Availability of credit and cheque tendering depends on the programming. (Only for the exchange 1)

Example

Preset exchange rate (1.550220) :EX1

| Key operation | Print |
|---|---|
| Currency exchange → [6] [7] PAYMENT MENU 3 (Select "EXCH1") Amount tendered in foreign currency → 12000 [TL/NS] | <pre> 1x 23.00 *23.00 PLU00006 1x 46.50 *46.50 PLU00007 ***TOTAL *69.50 EXCH1 1.550220 107.74 CASH 120.00 CHANGE *7.90 </pre> |

Received-on-account entries

From the FUNCTION MENU, select RA option to proceed the operation. You cannot receive RA in foreign currency.

Procedure

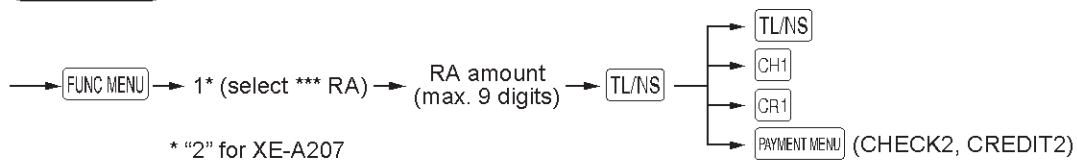

Example

| Key operation | Print |
|--|--|
| 12345 [#/TM/ST] [FUNC MENU] 1* (select *** RA) 4800 [TL/NS] [CH1] * "2" for XE-A207 | <pre> #00000000000012345 CHECK1 ***RA *48.00 </pre> |

Paid-out entries

You can make a payment by cash, check or credit.

Procedure

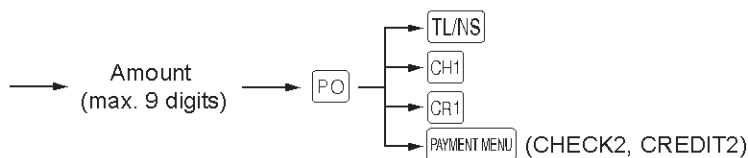

Example

| Key operation | Print |
|--|---|
| 6789 [#/TM/ST] 3000 [PO] [TL/NS] | <pre> #0000000000006789 CASH ***PO *30.00 </pre> |

■ No-sale (exchange)

Simply press the **[TL/NS]** key without any entry. The drawer will open and the printer will print "NO SALE" on the receipt. If you let your machine print a non-add code number before pressing the **[TL/NS]** key, a no sale entry is achieved with a non-add code number printed.

Print

NO SALE

■ Cashing a check

When you need to cash a check, enter the check amount and press a check key (**[CH1]**).

| Example | Key operation | Print |
|---------|--|---|
| | 6789 [#/TM/ST] 3000 [CH1] | #0000000000006789 CA/CHK *30.00 |

Electronic Journal View

The transaction data is kept in the electronic journal memory.

To display the journal data, press the **[EJ VIEW]** key, the last transaction data is displayed.

To retroact to past transaction data, press the **[EJ VIEW]** key repeatedly.

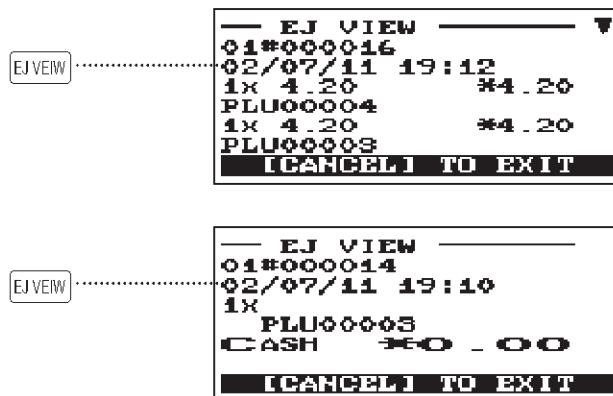

To exit the electronic journal view, press the **[ESC/CANCEL]** key.

TRAINING Mode

The training mode is used when the operator or the manager practices register operations.

When a clerk set in training is selected, the register automatically enters the training mode, while a clerk not set in training is selected, the register automatically enters the ordinary REG mode. A training text and a training clerk can be programmed.

The training operations are valid in all modes.

A mark which is identifying a training receipt is printed on the receipt which is issued in the training mode.

The consecutive number is not updated. The preceding number is repeated in printing.

Training clerk programming is performed in PGM mode.(It allows only for 1 Clerk.)

The memory in clerk is updated in the training mode. Other memories are not updated.

The GLU codes which are opened in the training mode are also printed on the GLU report. In this case, those GLU codes are distinguished from others by the character of "T." The data of training GLU codes are not added to the total.

The reading and resetting of training clerks is printed on the clerk reports. However, the sales total of training clerks is not included in the clerk total on the full clerk report.

| Key operation | Print |
|---------------------------------------|--------------------|
| Selecting the clerk set in training | TRAINING |
| <input type="checkbox"/> 5 | 1x 2.25 #2.25 |
| 3 <input checked="" type="checkbox"/> | PLU00005 |
| <input type="checkbox"/> 3 | 3x 4.20 #12.60 |
| TL/NS | PLU00003 |
| | CASH *14.85 |

5 Correction

Correction of the Last Entry (Direct Void)

If you make an incorrect entry relating to a department, PLU/subdepartment, percentage (%1, %2), discount (⊖), or item refund, you can void this entry by pressing the ∞ key immediately.

Example

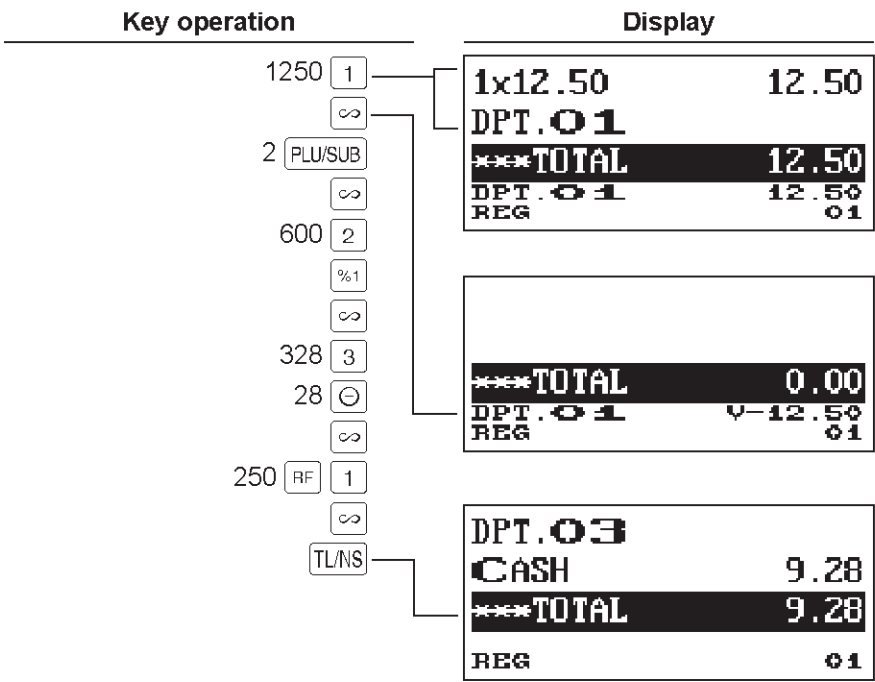

Correction of the Next-to-Last or Earlier Entries (Indirect Void)

If you find an incorrect entry before finalizing the transaction (e.g. before pressing the **TL/NS** key), you can void the entry by the cursor operation or the key sequence operation.

Indirect void by cursor operation

You can void department, PLU/subdepartment, item refund, amount discount/premium and percent entries.

Move the cursor to the item to be voided, and press the **↵** key.

Indirect void by key sequence operation

You can void department, PLU/subdepartment and item refund.

Press the **↵** key just before you press a department key, **DEPT#** key, direct PLU key or **PLU/SUB** key. For the refund indirect void, press the **↵** key after you press the **RF** key.

Example

(Indirect void by cursor operation)

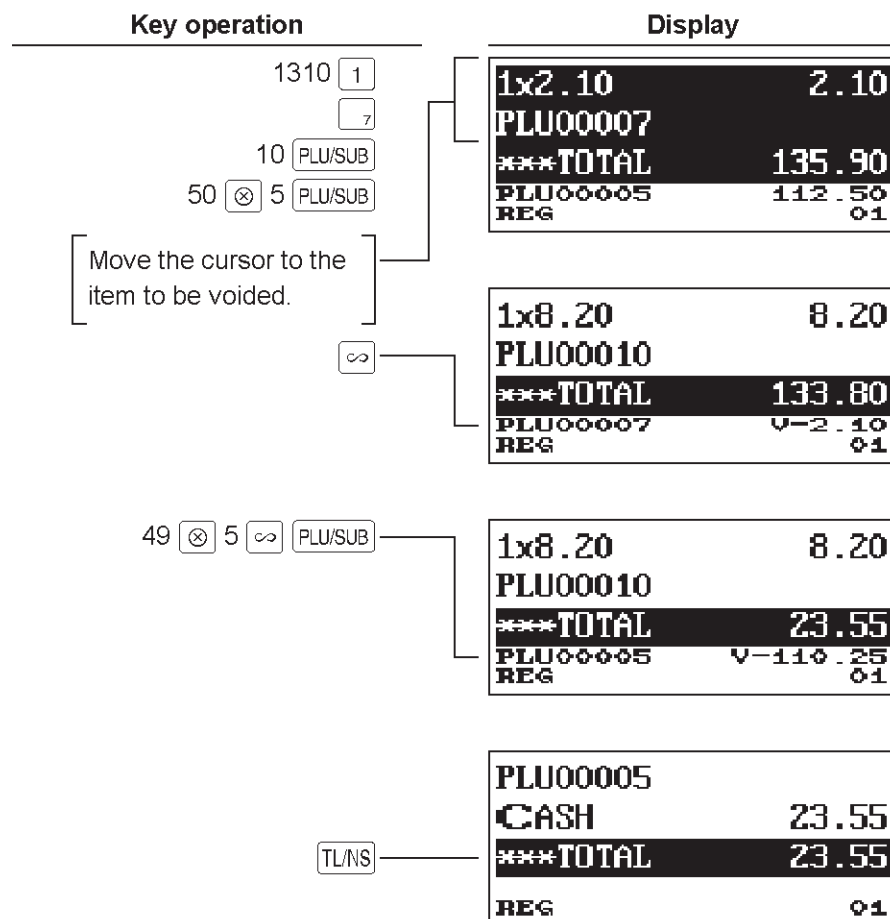

Subtotal Void

You can void an entire transaction. Once subtotal void is executed, the transaction is aborted and the register issues a receipt.

| Example | Key operation | Display | | | | | | | | |
|-----------|---|--|-----------|--------|----------|------|----------|------|-----|----|
| | <div style="display: flex; flex-direction: column; align-items: center;"> <div style="margin-bottom: 5px;">1</div> <div style="margin-bottom: 5px;">2</div> <div style="margin-bottom: 5px;">10 PLU/SUB</div> <div style="margin-bottom: 5px;">Subtotal void { #/TM/ST</div> <div style="margin-bottom: 5px;">∞</div> <div style="margin-bottom: 5px;">#/TM/ST</div> </div> | <table border="1" style="width: 100%; border-collapse: collapse;"> <tr> <td style="padding: 2px;">SBTL VOID</td> <td style="text-align: right; padding: 2px;">-10.45</td> </tr> <tr> <td style="padding: 2px;">***TOTAL</td> <td style="text-align: right; padding: 2px;">0.00</td> </tr> <tr style="background-color: #f0f0f0;"> <td style="padding: 2px;">***TOTAL</td> <td style="text-align: right; padding: 2px;">0.00</td> </tr> <tr> <td style="padding: 2px;">REG</td> <td style="text-align: right; padding: 2px;">01</td> </tr> </table> | SBTL VOID | -10.45 | ***TOTAL | 0.00 | ***TOTAL | 0.00 | REG | 01 |
| SBTL VOID | -10.45 | | | | | | | | | |
| ***TOTAL | 0.00 | | | | | | | | | |
| ***TOTAL | 0.00 | | | | | | | | | |
| REG | 01 | | | | | | | | | |

Correction after Finalizing a Transaction

When you need to void incorrect entries that are found after finalizing a transaction or cannot be corrected by direct, indirect or subtotal void, follow this procedure.

1. Select "3 VOID MODE" in the mode selection window.
2. Repeat the entries that are recorded on an incorrect receipt. (All data in the incorrect receipt is removed from register memory; the voided amounts are added to the void mode totalizer.)

| Incorrect receipt | Cancellation receipt | | | | | | | | | | | | | | | | | | | | | | | | | | | | | | | | | | | | | | | | | | | | | |
|---|----------------------|--------------|-------|------------|--|--------|---------|--|-------|----------|--|--|---------|--|-------|----------|--|--|-------------|--|--------------|---|---------|------------|-------|------------|--|--------|--|--|-------------|---------|--|-------|----------|--|--|---------|--|-------|----------|--|--|-------------|--|--------------|
| <table style="width: 100%; border-collapse: collapse;"> <tr> <td style="width: 30%;">#000101</td> <td style="width: 30%;">02/08/2011</td> <td style="width: 40%;">19:00</td> </tr> <tr> <td>01 CLERK01</td> <td></td> <td>000000</td> </tr> <tr> <td>3x 1.20</td> <td></td> <td style="text-align: right;">*3.60</td> </tr> <tr> <td>PLU00001</td> <td></td> <td></td> </tr> <tr> <td>1x 2.50</td> <td></td> <td style="text-align: right;">*2.50</td> </tr> <tr> <td>PLU00002</td> <td></td> <td></td> </tr> <tr> <td>CASH</td> <td></td> <td style="text-align: right;">*6.10</td> </tr> </table> | #000101 | 02/08/2011 | 19:00 | 01 CLERK01 | | 000000 | 3x 1.20 | | *3.60 | PLU00001 | | | 1x 2.50 | | *2.50 | PLU00002 | | | CASH | | *6.10 | <table style="width: 100%; border-collapse: collapse;"> <tr> <td style="width: 30%;">#000102</td> <td style="width: 30%;">02/08/2011</td> <td style="width: 40%;">19:05</td> </tr> <tr> <td>01 CLERK01</td> <td></td> <td>000000</td> </tr> <tr> <td></td> <td></td> <td style="text-align: center;">*VOID MODE*</td> </tr> <tr> <td>3x 1.20</td> <td></td> <td style="text-align: right;">*3.60</td> </tr> <tr> <td>PLU00001</td> <td></td> <td></td> </tr> <tr> <td>1x 2.50</td> <td></td> <td style="text-align: right;">*2.50</td> </tr> <tr> <td>PLU00002</td> <td></td> <td></td> </tr> <tr> <td>CASH</td> <td></td> <td style="text-align: right;">*6.10</td> </tr> </table> | #000102 | 02/08/2011 | 19:05 | 01 CLERK01 | | 000000 | | | *VOID MODE* | 3x 1.20 | | *3.60 | PLU00001 | | | 1x 2.50 | | *2.50 | PLU00002 | | | CASH | | *6.10 |
| #000101 | 02/08/2011 | 19:00 | | | | | | | | | | | | | | | | | | | | | | | | | | | | | | | | | | | | | | | | | | | | |
| 01 CLERK01 | | 000000 | | | | | | | | | | | | | | | | | | | | | | | | | | | | | | | | | | | | | | | | | | | | |
| 3x 1.20 | | *3.60 | | | | | | | | | | | | | | | | | | | | | | | | | | | | | | | | | | | | | | | | | | | | |
| PLU00001 | | | | | | | | | | | | | | | | | | | | | | | | | | | | | | | | | | | | | | | | | | | | | | |
| 1x 2.50 | | *2.50 | | | | | | | | | | | | | | | | | | | | | | | | | | | | | | | | | | | | | | | | | | | | |
| PLU00002 | | | | | | | | | | | | | | | | | | | | | | | | | | | | | | | | | | | | | | | | | | | | | | |
| CASH | | *6.10 | | | | | | | | | | | | | | | | | | | | | | | | | | | | | | | | | | | | | | | | | | | | |
| #000102 | 02/08/2011 | 19:05 | | | | | | | | | | | | | | | | | | | | | | | | | | | | | | | | | | | | | | | | | | | | |
| 01 CLERK01 | | 000000 | | | | | | | | | | | | | | | | | | | | | | | | | | | | | | | | | | | | | | | | | | | | |
| | | *VOID MODE* | | | | | | | | | | | | | | | | | | | | | | | | | | | | | | | | | | | | | | | | | | | | |
| 3x 1.20 | | *3.60 | | | | | | | | | | | | | | | | | | | | | | | | | | | | | | | | | | | | | | | | | | | | |
| PLU00001 | | | | | | | | | | | | | | | | | | | | | | | | | | | | | | | | | | | | | | | | | | | | | | |
| 1x 2.50 | | *2.50 | | | | | | | | | | | | | | | | | | | | | | | | | | | | | | | | | | | | | | | | | | | | |
| PLU00002 | | | | | | | | | | | | | | | | | | | | | | | | | | | | | | | | | | | | | | | | | | | | | | |
| CASH | | *6.10 | | | | | | | | | | | | | | | | | | | | | | | | | | | | | | | | | | | | | | | | | | | | |

NOTE Your register leaves the VOID mode whenever a transaction is canceled (i.e. finalized in the VOID mode). To void additional transactions, repeat steps 1 and 2 above.

6 Special Printing Function

Copy Receipt Printing

If your customer wants a receipt after you have finalized a transaction with the receipt ON-OFF function in the OFF status (no receipting), press the **FUNC MENU** key and "4" key for receipting (for XE-A217). Your register can also print a copy receipt when the receipt ON-OFF function is in the "ON" status.

For XE-A207, press the **FUNC MENU** key and "5" key.

Procedure

XE-A217W/XE-A217B

FUNC MENU → 4 (Select "RCPT")

XE-A207W/XE-A207B

FUNC MENU → 5 (Select "RCPT")

Example

Printing a receipt after making the entries shown below with the receipt ON-OFF function "OFF" status

| Key operation | Print | | | | | | | | | | |
|--|---|---------|-------|----------|--|---------|-------|----------|--|-------------|--------------|
| <div style="display: flex; flex-direction: column; align-items: center; gap: 5px;"> <div style="border: 1px solid black; padding: 2px 5px;">2</div> <div style="display: flex; align-items: center;">3 ⊗</div> <div style="border: 1px solid black; padding: 2px 5px;">1</div> <div style="border: 1px solid black; padding: 2px 5px;">TL/NS</div> </div> <p style="margin-top: 20px;">For receipting → FUNC MENU 4*</p> <p>* "5" for XE-A207</p> | Print on the receipt <div style="border: 1px solid black; padding: 10px; margin-left: 20px; display: inline-block;"> <table style="width: 100%; border-collapse: collapse;"> <tr> <td style="width: 60%;">1x 2.50</td> <td style="text-align: right;">*2.50</td> </tr> <tr> <td>PLU00002</td> <td></td> </tr> <tr> <td>3x 1.20</td> <td style="text-align: right;">*3.60</td> </tr> <tr> <td>PLU00001</td> <td></td> </tr> <tr> <td>CASH</td> <td style="text-align: right;">*6.10</td> </tr> </table> </div> | 1x 2.50 | *2.50 | PLU00002 | | 3x 1.20 | *3.60 | PLU00001 | | CASH | *6.10 |
| 1x 2.50 | *2.50 | | | | | | | | | | |
| PLU00002 | | | | | | | | | | | |
| 3x 1.20 | *3.60 | | | | | | | | | | |
| PLU00001 | | | | | | | | | | | |
| CASH | *6.10 | | | | | | | | | | |

"COPY" is printed on the copy receipt.

| | |
|---------------|--------------|
| *COPY* | |
| 1x 2.50 | *2.50 |
| PLU00002 | |
| 3x 1.20 | *3.60 |
| PLU00001 | |
| CASH | *6.10 |

Guest Check Receipt(Bill Print)

You can use this function when you want to take a bill for guest check.

Procedure

XE-A217W/XE-A217B

→ **G.C. RCPT**

XE-A207W/XE-A207B

→ **FUNC MENU** → 1 (select "G.C.RCPT")

NOTE

- This function is available immediately after the finalization of transaction.
- You can also print the bill copy on receipt only once. When you want to take a bill copy, operate it again.

Example

Key operation

10 **⊗** **1**
TL/NS
G.C. RCPT

G.C. RCPT

Print

| | |
|---------------|---------------|
| *BILL* | |
| 10x 1.20 | *12.00 |
| PLU00001 | |
| CASH | *12.00 |

| | |
|---------------|---------------|
| *COPY* | |
| *BILL* | |
| 10x 1.20 | *12.00 |
| PLU00001 | |
| CASH | *12.00 |

7 Manager Mode

The manager mode is used when managerial decisions must be made concerning register entries, for example, for overriding limitations and for other various non-programming managerial tasks.

NOTE Normal register operations may also be performed in this mode.

Entering the Manager Mode

To enter the manager mode, use the following procedure in the REG mode:

Procedure

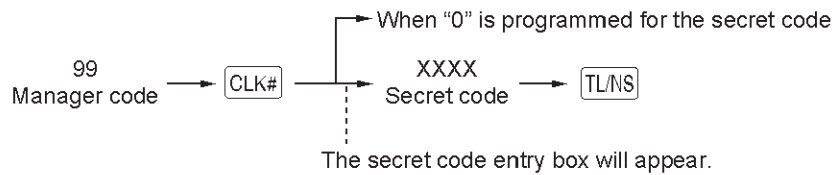

Example

If the code is correct, the register enters the manager mode.

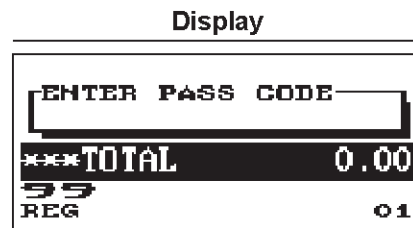

Override Entries

Programmed limits (such as maximum amounts) for functions can be overridden by placing the register in the manager mode.

Example

This example presumes that the register has been programmed not to allow coupon entries over 2.00.

| Key operation | Print | | | | | | | | |
|---|--|---------|-------|----------|--|-----|-------|-------------|--------------|
| REG-mode entries { <ul style="list-style-type: none"> 250 <input type="text" value="3"/> Error CL | <table border="0" style="width: 100%;"> <tr> <td style="width: 70%;">1x 3.00</td> <td style="text-align: right;">*3.00</td> </tr> <tr> <td>PLU00003</td> <td></td> </tr> <tr> <td>(-)</td> <td style="text-align: right;">-2.50</td> </tr> <tr> <td>CASH</td> <td style="text-align: right;">*0.50</td> </tr> </table> | 1x 3.00 | *3.00 | PLU00003 | | (-) | -2.50 | CASH | *0.50 |
| 1x 3.00 | | *3.00 | | | | | | | |
| PLU00003 | | | | | | | | | |
| (-) | -2.50 | | | | | | | | |
| CASH | *0.50 | | | | | | | | |
| Enter to the manager mode — 99 <input type="text" value="CLK#"/> | | | | | | | | | |
| 250 <input type="text" value="0"/> | | | | | | | | | |
| <input type="text" value="TL/NS"/> | | | | | | | | | |

NOTE

- When a transaction is finalized, manager is automatically signed off.
- In the initial programming, the HALO function is programmed as "INVALID".

8

Reading (X) and Resetting (Z) of Sales Totals

- Use the reading function (X) when you need to take the reading of sales information entered after the last resetting. You can take this reading any number of times. It does not affect the register's memory.
- Use the resetting function (Z) when you need to clear the register's memory. Resetting prints all sales information and clears the entire memory except for the GT1 through GT3, reset count, and consecutive number.
- X1 and Z1 reports show daily sales information. You can take these reports in the X1/Z1 mode.
- X2 and Z2 reports show periodic (monthly) consolidation information. You can take these reports in the X2/Z2 mode.
- In the OPXZ mode, a clerk can take his or her report.
- If you want to stop the printing report, press the **ESC/CANCEL** key.

■ How to take a X1/Z1 or X2/Z2 report

[To take an X1 or X2 report:]

1. Press the **MODE** key.
2. Select the "4 X1/Z1 MODE" or "5 X2/Z2 MODE" by using the **↓** key, and press the **TL/NS** key.
3. Select "2 READING" in the X1/Z1 mode or select "1 READING" in the X2/Z2 mode menu window and press in both cases the **TL/NS** key to display the items list.
4. Select the appropriate report title.
5. Press the **TL/NS** key.

[To take a Z1 or Z2 report:]

1. Press the **MODE** key.
2. Select the "4 X1/Z1 MODE" or "5 X2/Z2 MODE" by using the **↓** key, and press the **TL/NS** key.
3. Select "3 RESETTING" in the X1/Z1 mode or select "2 RESETTING" in the X2/Z2 mode menu window and press in both cases the **TL/NS** key to display the items list.
4. Select the appropriate report title.
5. Press the **TL/NS** key.

■ Flash report

You can take flash reports (display only) in the X1/Z1 mode for department sales, cash in drawer (CID) and sales total at the point you take the report.

1. Press the **MODE** key.
2. Select the "4 X1/Z1 MODE" by using the **↓** key, and press the **TL/NS** key.
3. Select the "1 FLASH READ", and press the **TL/NS** key.
4. Select "1 DEPT. SALES" to take a flash report of department sales, "2 CID" to take a flash report of cash in drawer, or "3 SALES TOTAL" to take a flash report of sales total.
5. Press the **TL/NS** key.

| Item | Mode | | | | | |
|-------------------------------------|------|---|-------|---|-------|---|
| | OPXZ | | X1/Z1 | | X2/Z2 | |
| | X | Z | X | Z | X | Z |
| General report | | | ○ | ○ | ○ | ○ |
| PLU report by designated range | | | ○ | ○ | | |
| PLU report by associated department | | | ○ | ○ | | |
| Individual clerk report | ○ | ○ | ○ | ○ | | |
| All clerk report | | | ○ | ○ | | |
| Hourly report | | | ○ | ○ | | |
| GLU report * | | | ○ | ○ | | |
| GLU report by clerk* | | | ○ | ○ | | |
| Balance report * | | | ○ | | | |
| Flash report | | | ○ | | | |

*: For XE-A217W/XE-A217B only

Daily Sales Totals

General report

Sample X report

| *X1* | | Read symbol |
|-------------|-----------|--|
| DEPT./GROUP | | Report title |
| D01 | 230.500 Q | Dept. code |
| DPT.01 | *1314.95 | Sales q'ty |
| | 59.01% | Dept. description and sales amount |
| | | Ratio of dept. 1 sales amount to "+" dept. total |
| D02 | 99.000 Q | |
| DPT.02 | *257.51 | |
| | 11.56% | |
| D03 | 59.500 Q | |
| DPT.03 | *504.56 | |
| | 22.64% | |
| D04 | 8.000 Q | |
| DPT.04 | *53.80 | |
| | 2.41% | |
| D05 | 16.000 Q | |
| DPT.05 | *94.63 | |
| | 4.25% | |
| D06 | 1.000 Q | |
| DPT.06 | *3.00 | |
| | 0.13% | |
| GROUP01 | 414.000 Q | Group 1 total q'ty |
| | *2228.45 | Group 1 total amount |
| | 100.00% | Ratio of dept. group 1 sales amount to "+" dept. total |
| ----- | | Group 1 text |
| *DEPT TL | 414.000 Q | "+" dept. sales q'ty and total |
| | *2228.45 | |
| | 100.00% | |

| | | |
|----------|---------|-------------------------------------|
| D10 | 1.000 Q | "- dept. sales q'ty and total |
| DPT. 10 | -15.00 | |
| DEPT (-) | 1.000 Q | "Hash "+" dept.sales q'ty and total |
| | -15.00 | |
| ----- | | |
| D11 | 1.000 Q | "Hash "-" dept.sales q'ty and total |
| DPT. 11 | *11.00 | |
| *HASH TL | 1.000 Q | |
| | *11.00 | |
| ----- | | |
| D12 | 2.000 Q | "Hash "-" dept.sales q'ty and total |
| DPT. 12 | -24.00 | |
| HASH (-) | 2.000 Q | |
| | -24.00 | |

Sample Z report

| *Z1* | | Reset counter |
|-------------|-----------------|--|
| | Z1 0001 | Net grand total (GT2-GT3) |
| GT1 | *00000001437.61 | Grand total of plus registration |
| GT2 | *00000001561.99 | Grand total of minus registration |
| GT3 | -00000000124.38 | Order - paid total |
| BAL | *00000000064.20 | Grand total of training-mode registrations |
| TR | *00000000050.80 | |
| ----- | | |
| DEPT./GROUP | | |

The subsequent printout occurs in the same format as in the sample X1 report.

| TRANSACTION | | Report title |
|-------------|----------|---|
| (-) | 2 Q | Subtotal (-) counter and total |
| | -1.10 | |
| %1 | 2 Q | Subtotal % counter and total |
| | -4.11 | |
| ----- | | |
| TAX1 ST | *1588.79 | Taxable 1 total |
| VAT 1 | *0.00 | VAT 1 total |
| TAX2 ST | *575.46 | |
| VAT 2 | *0.26 | |
| TTL TAX | *0.26 | total tax |
| NET | *2228.45 | Net sales total without tax |
| VAT SFT | *70.90 | |
| NET2 | *2228.71 | Net sales total with tax |
| ----- | | |
| (-) | 3 Q | Item (-) counter and total |
| | -3.75 | |
| %2 | 2 Q | Item % counter and total |
| | -3.83 | |
| REFUND | 7 Q | Refund counter and total |
| | *51.00 | |
| VOID | 9 Q | Item void counter and total |
| | *96.94 | |
| VOID MODE | 1 Q | Void-mode transaction counter and total |
| | *19.50 | |
| MGR VOID | 7 Q | Void mode item counter and total |
| | *19.50 | |
| SBTL VOID | 18 Q | Subtotal void counter and total |
| | *221.76 | |
| HASH VOID | 1 Q | Hash item void counter and total |
| | *11.00 | |
| HASH RF | 1 Q | Hash item refund counter and total |
| | *11.00 | |
| ----- | | |
| BILL CNT | 27 Q | Bill print counter |
| NO SALE | 7 Q | No-sale (exchange) counter |
| ***PBAL | 27 Q | PBAL counter |
| GUEST | 89 Q | Transaction counter |
| ----- | | |

| | | |
|---------------|----------|---|
| ORDER TL | *2228.71 | Order total |
| PAID TL | *2164.51 | Paid total |
| AVE. | *24.32 | Paid total average per transaction counter |
| O-P | *64.20 | Order total - paid total |
| SCM(+) | *4.00 | Starting cash memory (+) |
| SCM(-) | -1.50 | Starting cash memory (-) |
| SCM TTL | *2.50 | Starting cash memory total |
| ***RA | 1 Q | Received-on-account counter and total |
| | *48.00 | |
| ***PO | 2 Q | Paid-out counter and total |
| | *1.10 | |
| ----- | | |
| CASH | 70 Q | Cash counter and total |
| | *1756.28 | |
| CHECK1 | 11 Q | Check 1 sale counter and total |
| | *100.80 | |
| CHECK2 | 5 Q | |
| | *60.60 | |
| CREDIT1 | 4 Q | Credit 1 sale and tendering counter and total |
| | *14.00 | |
| CREDIT2 | 3 Q | |
| | *32.40 | |
| EXCH1 | 2 Q | Exchange 1 cash counter and total |
| | 240.00 | |
| DOM. CUR1 | *191.68 | Domestic currency for exchange 1 total |
| EX1 CHK | 0 Q | Exchange 1 check counter and total |
| | 0.00 | |
| DOM. CUR1 CHK | *0.00 | |
| EX1 CR | 0 Q | Exchange 1 credit counter and total |
| | 0.00 | (Exchange1:for the programmed rate) |
| DOM. CUR1 CR | *0.00 | (Exchange2:for the open rate) |
| EXCH2 | 2 Q | |
| | 8280.10 | |
| DOM. CUR2 | *69.83 | |

| | | |
|-----------|----------|----------------------------------|
| ***CID | *1696.60 | Cash in drawer |
| *CH ID | *209.40 | Check in drawer |
| CA/CHK ID | *1906.00 | Cash+check in drawer |
| CHK/CG | *8.40 | Change total for check tendering |

■ PLU report by designated range

| *X1* | | * |
|----------|----------|--------------------------------------|
| PLU | | |
| | 00001- | 00010 |
| | | |
| PLU | | |
| P00001 | 6.000 Q | |
| PLU00001 | *0.00 | Sales q'ty and sales amount |
| P00002 | 1.000 Q | |
| PLU00002 | *0.00 | |
| P00003 | 9.000 Q | |
| PLU00003 | *21.00 | |
| P00004 | 1.000 Q | |
| PLU00004 | *4.20 | |
| ----- | | |
| P00010 | *8.20 | |
| PLU00010 | | |
| ----- | | |
| ***TOTAL | 25.000 Q | Total sales q'ty and amount for PLUs |
| | *44.50 | |

* When you take a Z report, "Z1" is printed instead of "X1."

NOTE In case of a PLU X report only header information is stored in the Electronic Journal file.

■ PLU report by associated department

| *X1* | | * |
|-------------|-----------|------------------------------------|
| PLU BY DEPT | | |
| DPT.02 | D02 | Description of associated dept |
| | | Associated dept. code |
| PLU | | PLU code |
| P00002 | 38.000 Q | |
| PLU00002 | *171.00 | Sales q'ty and sales amount |
| P00003 | 8.000 Q | |
| PLU00003 | *24.80 | |
| P00007 | 65.000 Q | |
| PLU00007 | *140.40 | |
| P00010 | 46.000 Q | |
| PLU00010 | *354.50 | |
| P00012 | 12.000 Q | |
| PLU00012 | *144.00 | |
| ----- | | |
| ***TOTAL | 169.000 Q | PLU total of associated department |
| | *834.70 | |

* When you take a Z report, "Z1" is printed instead of "X1."

Individual clerk report

| *X1* | | * |
|---------------|----------|---|
| IND. CLERK | | Clerk code |
| CLK#01 | CLERK01 | Clerk name |
| ORDER TL | *2233.51 | Order total |
| PAID TL | *2169.31 | Paid total |
| AVE. | *24.93 | Paid total average per transaction counter |
| O-P | *64.20 | Order total-paid total |
| REFUND | 2 Q | |
| | *45.00 | Refund counter and total |
| VOID | 9 Q | Item void counter and total |
| | *96.94 | |
| VOID MODE | 1 Q | Void-mode transaction counter and total |
| | *19.50 | |
| MGR VOID | 7 Q | Void mode item counter and total |
| | *19.50 | |
| SBTL VOID | 18 Q | Subtotal void counter and total |
| | *221.76 | |
| ***PBAL | 27 Q | PBAL counter |
| GUEST | 87 Q | Transaction counter |
| ----- | | |
| SCN(+) | *4.00 | Starting cash memory (+) |
| SCN(-) | -1.50 | Starting cash memory (-) |
| SCN TTL | *2.50 | Starting cash memory total |
| ***RA | 1 Q | Received-on-account counter and total |
| | *48.00 | |
| ***PO | 2 Q | Paid-out counter and total |
| | *1.10 | |
| ----- | | |
| CASH | 68 Q | Cash counter and total |
| | *1761.08 | |
| CHECK1 | 11 Q | Check 1 sale counter and total |
| | *100.80 | |
| CHECK2 | 5 Q | |
| | *60.60 | |
| CREDIT1 | 4 Q | Credit 1 sale and tendering counter and total |
| | *14.00 | |
| CREDIT2 | 3 Q | |
| | *32.40 | |
| EXCH1 | 2 Q | Exchange 1 cash counter and total |
| | 240.00 | |
| DOM. CUR1 | *191.68 | |
| EX1 CHK | 0 Q | Exchange 1 check counter and total |
| | 0.00 | |
| DOM. CUR1 CHK | *0.00 | |
| EX1 CR | 0 Q | Exchange 1 credit counter and total |
| | 0.00 | |
| ----- | | |
| ***CID | *1701.40 | Cash in drawer |
| *CH ID | *209.40 | Check in drawer |
| CA/CHK ID | *1910.80 | Cash + check in drawer |
| CHK/CG | *8.40 | Change total for check tendering |

* When you take a Z report, "Z1" is printed instead of "X1."

All clerk report

| *X1* | | * |
|-----------|---------|---|
| ALL CLERK | | |
| CLK#01 | CLERK01 | |



The subsequent printout occurs in the same format as in the individual clerk report from the clerk #1. In the all clerk report, the total sales of all clerks are also printed.

* When you take a Z report, "Z1" is printed instead of "X1."

Hourly report

| *X1* | | * |
|----------|---------|-------------------------|
| HOURLY | | |
| 18:00 | 12 Q | Time |
| | *122.00 | Transaction counter |
| AVE. | *10.17 | Sales total |
| 18:30 | 4 Q | Average of sales amount |
| | *175.87 | |
| AVE. | *43.97 | |
| SUBTOTAL | 16 Q | |
| | *297.87 | |

| | |
|----------|---------|
| AVE. | *79.24 |
| 22:30 | 0 Q |
| | *0.00 |
| AVE. | *0.00 |
| SUBTOTAL | 3 Q |
| | *237.71 |

* When you take a Z report, "Z1" is printed instead of "X1."

GLU report (for XE-A217W/XE-A217B only)

| *X1* | | * |
|-----------|-----------|---|
| GLU | | |
| | 0001-9999 | GLU code |
| | | Range |
| GLU#12 | 01 | Clerk code |
| ***PBAL | *1.20 | PBAL |
| GLU#1001 | 01 | |
| ***PBAL | *49.50 | |
| GLU#1002 | 01 | |
| ***PBAL | *16.80 | |
| GLU#1003 | 01 | |
| ***PBAL | *22.50 | |
| GLU#1005T | 04 | |
| ***PBAL | *26.70 | "T": This GLU code was used in the training mode. |
| ----- | | |
| ***TOTAL | | Total |
| ***PBAL | *90.00 | |

* When you take a Z report, "Z1" is printed instead of "X1."

■ GLU report by clerk (for XE-A217W/XE-A217B only)

| *X1* | | * |
|--------------|---------|--------------------------|
| GLU BY CLERK | | |
| CLK#01 | CLERK01 | Clerk code Clerk name |
| GLU#12 | | GLU code |
| ***PBAL | *1.20 | PBAL |
| GLU#1001 | | |
| ***PBAL | *49.50 | |
| GLU#1002 | | |
| ***PBAL | *16.80 | |
| GLU#1003 | | |
| ***PBAL | *22.50 | |
| ----- | | |
| ***TOTAL | | } Total |
| ***PBAL | *90.00 | |

* When you take a Z report, "Z1" is printed instead of "X1."

■ Balance report (for XE-A217W/XE-A217B only)

| *X1* | | |
|----------|----------|---|
| BALANCE | | |
| OLD BAL. | | Grand total balance of the previous day |
| | *0.00 | Order total |
| ORDER TL | *2228.71 | Paid total |
| PAID TL | *2164.51 | |
| BALANCE | | |
| | *64.20 | Old balance + today's balance |

Periodic Report Sample

Your register allows you to take consolidation X and Z reports of a chosen period (the period is usually one week or month).

■ General information

The periodic reading or resetting reports are the same in format as those in the X1/Z1 report for daily sales information except mode indication ("X2" or "Z2").

• Sample X report

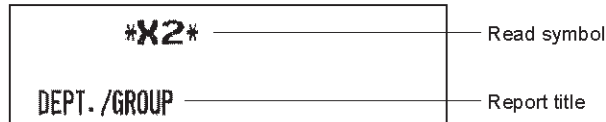

• Sample Z report

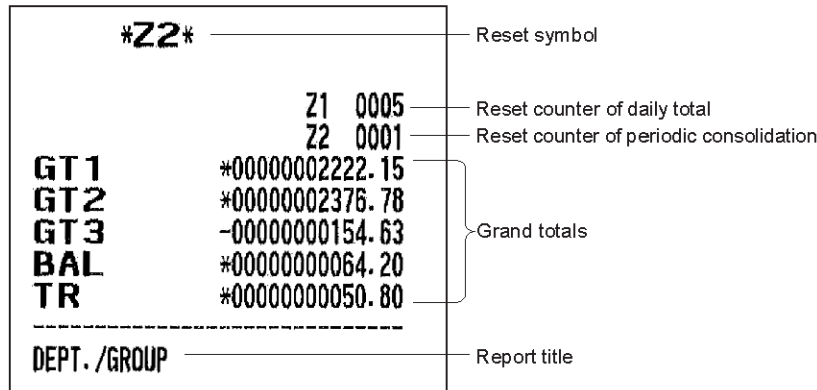

The subsequent items are printed out in the same format as in the X/Z report on daily totals.

9 Prior to Programming

When you are in the PGM mode, the keyboard layout will be set to one of the programming layouts as shown below.





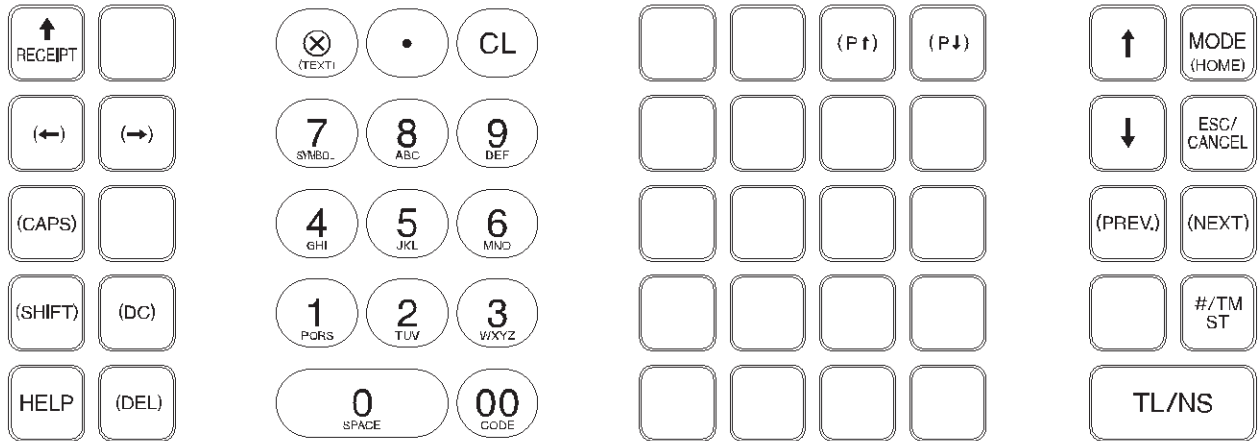



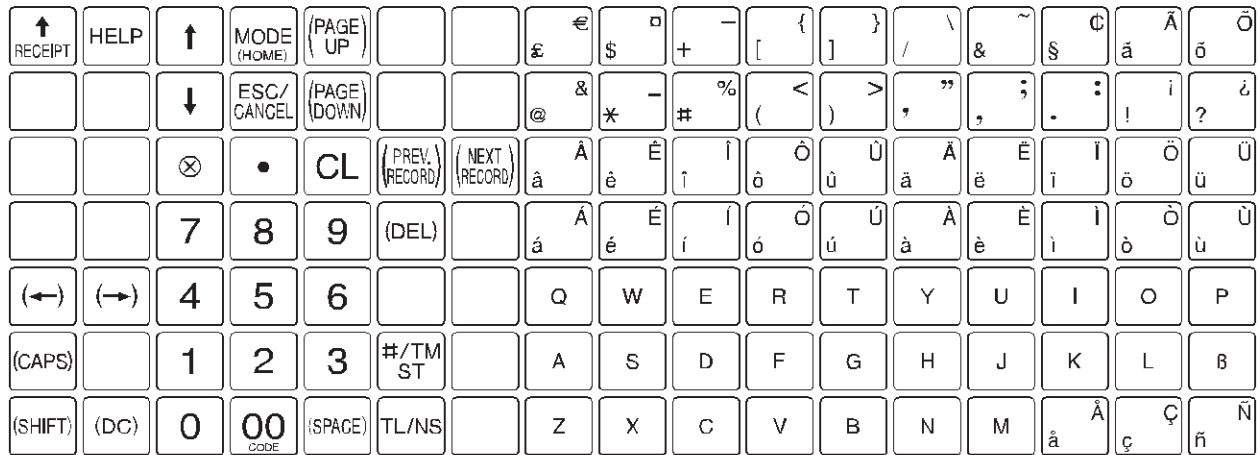















Programming Keyboard Layout

XE-A207W/XE-A207B



XE-A217W/XE-A217B



- 





: Used for programming characters. For more information about programming characters, see the section “How to Program Alphanumeric Characters.”
- 



: Used to move the cursor.
- 
: Used to program each setting and to finalize programming.
- 
: Used to cancel programming and to get back to the previous screen.
- 
or

: Used to go back to the previous record, e.g., from the department 2 programming window back to the department 1 programming window.
- 
or

: Used to go to the next record, for example, in order to program unit prices for sequential departments.
- 
or

: Used to scroll the window to go to the next page.
- 
or

: Used to scroll the window to go back to the previous page.
- 
: Used to clear the last setting you have programmed or clear the error state.
- 
: Used to toggle between two or more options.
- 
: Used to list those options which you can toggle by the  key.
- 
: Used to delete a record.
- Numeric keys : Used for entering figures.

How to Program Alphanumeric Characters

This section discusses how to program alphanumeric characters for various texts.

■ Mobile phone method (XE-A207W/XE-A207B only)

Entering alphanumeric characters

To enter a character, simply press a corresponding character key on the programming keyboard.

To enter "A", press the "8" key.

To enter "B", press the "8" key twice.

To enter "C", press the "8" key three times.

Entering double-size characters

(DC) : This key toggles the double-size character mode and the normal-size character mode. The default is the normal-size character mode. When the double-size character mode is selected, the letter "W" appears at the bottom of the display.

Entering upper-case letters

(SHIFT) : You can enter an upper-case letter by using this key. Press this key just before you enter the upper-case letter. You should press this key each time you enter an upper-case letter.

(CAPS) : You can lock the upper-case letter mode once the this key is pressed.

Entering space

(SPACE) : Enter a space in the cursor position.

To move the cursor

← **→** : Moves the cursor.

To delete a character or figure

(DEL) : Deletes a character or figure in the cursor position.

To change the text input mode

(TEXT) : This key toggles the text input mode, Alphabet(A),European character (Ä), numeral (1), and symbol (*).

■ PC keyboard method (XE-A217W/XE-A217B) (Key sheet layout)

You can enter a character using the primary character are located on PLU direct key area.

Entering double-size characters

(DC) : This key toggles the double-size character mode and the normal-size character mode. The default is the normal-size character mode. When the double-size character mode is selected, the letter "W" appears at the bottom of the display.

Entering upper-case letters

(SHIFT) : You can enter an upper-case letter by using this key. Press this key just before you enter the upper-case letter. You should press this key each time you enter an upper-case letter.

(CAPS) : You can lock the upper-case letter mode once the this key is pressed.

Entering space

(SPACE) : Enter a space in the cursor position.

To move the cursor

← **→** : Moves the cursor.

To delete a character or figure

(DEL) : Deletes a character or figure in the cursor position.

■ Entering character codes

Numerals, letters and symbols are programmable by entering the **00** key and character codes. Use the following procedure with the cursor placed at the position where you want to enter characters:

To enter a digit, simply press a corresponding numeric key.

→ **00** → XXX XXX : character code (3 digits)

Character code:

| | | | | | | | | | | | | | | | | |
|-----------|-----|-----|-----|-----|-----|-----|-----|-----|-----|-----|-----|-----|-----|-----|-----|------|
| 032 - 047 | 032 | 033 | 034 | 035 | 036 | 037 | 038 | 039 | 040 | 041 | 042 | 043 | 044 | 045 | 046 | 047 |
| | | ! | " | # | \$ | % | & | ' | (|) | * | + | , | - | . | / |
| 048 - 063 | 048 | 049 | 050 | 051 | 052 | 053 | 054 | 055 | 056 | 057 | 058 | 059 | 060 | 061 | 062 | 063 |
| | 0 | 1 | 2 | 3 | 4 | 5 | 6 | 7 | 8 | 9 | : | ; | < | = | > | ? |
| 064 - 079 | 064 | 065 | 066 | 067 | 068 | 069 | 070 | 071 | 072 | 073 | 074 | 075 | 076 | 077 | 078 | 079 |
| | @ | A | B | C | D | E | F | G | H | I | J | K | L | M | N | O |
| 080 - 095 | 080 | 081 | 082 | 083 | 084 | 085 | 086 | 087 | 088 | 089 | 090 | 091 | 092 | 093 | 094 | 095 |
| | P | Q | R | S | T | U | V | W | X | Y | Z | [| \ |] | ^ | _ |
| 096 - 111 | 096 | 097 | 098 | 099 | 100 | 101 | 102 | 103 | 104 | 105 | 106 | 107 | 108 | 109 | 110 | 111 |
| | ` | a | b | c | d | e | f | g | h | i | j | k | l | m | n | o |
| 112 - 127 | 112 | 113 | 114 | 115 | 116 | 117 | 118 | 119 | 120 | 121 | 122 | 123 | 124 | 125 | 126 | 127 |
| | p | q | r | s | t | u | v | w | x | y | z | { | | } | ~ | Δ |
| 128 - 143 | 128 | 129 | 130 | 131 | 132 | 133 | 134 | 135 | 136 | 137 | 138 | 139 | 140 | 141 | 142 | 143 |
| | Ç | ü | é | â | ä | à | ã | ç | ê | ë | è | ï | î | ì | Ä | Å |
| 144 - 159 | 144 | 145 | 146 | 147 | 148 | 149 | 150 | 151 | 152 | 153 | 154 | 155 | 156 | 157 | 158 | 159 |
| | É | æ | ƒ | ô | ö | ò | û | ù | ÿ | ö | Ü | ø | £ | Ø | × | ƒ |
| 160 - 175 | 160 | 161 | 162 | 163 | 164 | 165 | 166 | 167 | 168 | 169 | 170 | 171 | 172 | 173 | 174 | 175 |
| | á | í | ó | ú | ñ | Ñ | º | º | ¿ | ® | € | ½ | ¼ | ↓ | « | » |
| 176 - 191 | 176 | 177 | 178 | 179 | 180 | 181 | 182 | 183 | 184 | 185 | 186 | 187 | 188 | 189 | 190 | 191 |
| | ⋮ | ⋮ | ⋮ | | đ | Á | Â | À | © | € | | ñ | ž | ¢ | ¥ | € |
| 192 - 207 | 192 | 193 | 194 | 195 | 196 | 197 | 198 | 199 | 200 | 201 | 202 | 203 | 204 | 205 | 206 | 207 |
| | ¢ | à | æ | č | - | đ | ã | Ñ | ë | Ñ | Ř | š | ŧ | = | Ó | Ø |
| 208 - 223 | 208 | 209 | 210 | 211 | 212 | 213 | 214 | 215 | 216 | 217 | 218 | 219 | 220 | 221 | 222 | 223 |
| | ð | Đ | Ê | Ë | È | € | Í | Î | Ï | Ž | ƒ | ■ | ■ | ì | ì | ■ |
| 224 - 239 | 224 | 225 | 226 | 227 | 228 | 229 | 230 | 231 | 232 | 233 | 234 | 235 | 236 | 237 | 238 | 239 |
| | Ó | ß | Ô | Ò | Õ | Õ | µ | þ | þ | Ú | Û | Ù | Ý | Ý | - | ' |
| 240 - 255 | 240 | 241 | 242 | 243 | 244 | 245 | 246 | 247 | 248 | 249 | 250 | 251 | 252 | 253 | 254 | 255 |
| | - | ± | = | ¾ | ¶ | § | ÷ | , | ° | -- | . | 1 | 3 | 2 | ■ | (DC) |

*(DC) : Double-size character code

10 Programming

This chapter explains how to program various items.

Before you start programming, press the **MODE** key and select the "6 PGM MODE" or "7 SD CARD MODE" by using the **↓** key and press the **TL/NS** key.

Basic Instructions

This section illustrates the basic programming by using an example of programming for departments.

■ Programming screen

Opening screen: When you select the "6 PGM MODE", your display will show a programming opening screen corresponding to the mode you selected.

Mode you are in

PGM MODE
1 READING
2 SETTING

PGM 01

Programming menu: Use the cursor keys or numeric key to select an option, and press the **TL/NS** key.

Numeric entry and status information area

Code selecting screen (Dept. PLU):

PLU ▼

00001 PLU00001
00002 PLU00002

PGM 01

Selected menu

Code number and its description
(In case of PLU, two lines are used for one code, upper line - code, lower line - description.)
Use the cursor keys or numeric keys to select an option, and press the **TL/NS** key.

Numeric entry and status information area

Programming screen:

00001 PRICE 0.00 PLU00001
TYPE PRESET
DEPT.CODE 01

PGM 01

Selected code

Setting items:
Use the cursor keys to select an item.
To select an option, follow the instruction shown below.
Numeric entry: Use numeric keys
Character entry: Use character keys
Selective entry: Press **[]** key to toggle options or press the **#/TM/ST** key to show the option list. Use the cursor keys to move the cursor and press the **#/TM/ST** or **TL/NS** key to select it.

■ Programming example

Procedure

```

PGM MODE
1 READING
2 SETTING
-----
PGM                                01
  
```

TL/NS ↓ ↑ ESC/CANCEL

```

SETTING
1 ARTICLE
2 FUNCTIONS
3 MEDIA
4 FUNCTION TEXT
5 PERSONNEL
-----
PGM                                01
  
```

TL/NS ↓ ↑ ESC/CANCEL

```

ARTICLE
1 DEPARTMENT
2 PLU
3 PLU RANGE
-----
PGM                                01
  
```

TL/NS ↓ ↑ ESC/CANCEL

```

DEPARTMENT
01 DPT.01
02 DPT.02
03 DPT.03
04 DPT.04
05 DPT.05
-----
PGM                                01
  
```

TL/NS ↓ ↑ ESC/CANCEL

The following example shows how to program 2.00 for the unit price, "ABCDE" for the description, and "non-taxable 1" for department 1.

1. In the PGM MODE screen, select "2 SETTING" by using the ↓ key and press the **TL/NS** key.
 - The SETTING screen will appear.

NOTE

- You can also select "2 SETTING" by using numeric key "2," then press the **TL/NS** key.
- If you return to the previous screen, press the **ESC/CANCEL** key.

2. Select "1 ARTICLE."

- The ARTICLE screen will appear.

NOTE

The arrow mark in the upper-right corner of the window shows that the window contains more options than are now on the screen. To scroll the window, press the ↓ key (**PAGE DOWN** key). To return to the previous page, press the ↑ key (**PAGE UP** key).

3. Select "1 DEPARTMENT."

- The DEPARTMENT screen will appear, listing programmable departments.

4. Select "01 DPT.01" to program for department 1.

- The "01" window will appear.

```

01
PRICE          200
DPT. 01
TYPE          PRESET
TAX1          YES
TAX2          NO
TAX3          NO
PGM           01

```

```

01
PRICE          2.00
ABCDE
TYPE          PRESET
TAX1          YES
TAX2          NO
TAX3          NO
PGM           A 01

```

```

01
PRICE          2.00
ABCDE
TYPE          PRESET
TAX1          NO
TAX2          NO
TAX3          NO
PGM           01

```

- On the first page of the "01" window, program the unit price and description as follows:

NOTE

There are three entry patterns for the programming: the numeric entry, character entry, and selective entry.

- Move the cursor to "PRICE," enter "200" by using numeric keys. → Numeric entry
- Move the cursor to "DPT.01" enter "ABCDE" by using character keys. → Character entry

If you want to clear setting, press the **CL** key before you press the **↓** key, **(PAGE DOWN)** key, **↑** key, **(PAGE UP)** key, **TL/NS** key.

- Press the **↓** key twice to move the cursor to "TAX 1", then program the machine to set "non-taxable 1" as follows:

- Press the **□** key to select "NO." → Selective entry

NOTE

The **□** key toggles between two options as follows:

NO → YES → NO →

Pressing the **#TM/ST** key displays all pertinent options.

- Select one of the following actions:

- To cancel the programming, press the **ESC/CANCEL** key. A confirmation window appears to ask you whether to save the data; select the option you prefer.
- To finalize the programming, press the **TL/NS** key, then press the **ESC/CANCEL** key. You will return to the "DEPARTMENT" window.
- To program for the following department, press the **(NEXT RECORD)** (or **(NEXT)**) key. The "02" window will appear. To return to the "01" window, press the **(PREV. RECORD)** (or **(PREV)**) key.

The following sections describe how to program each item which is contained in a programming group.

Article Programming

Use the following procedure to select any option included in the article programming group:

Procedure

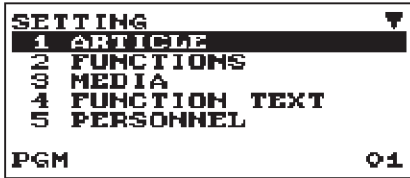

1. In the SETTING window, select "1 ARTICLE."
 - The ARTICLE window will appear.

2. Select any option from the following options list.

- | | |
|---------------|-----------------|
| 1 DEPARTMENT: | Departments |
| 2 PLU: | PLUs |
| 3 PLU RANGE: | A range of PLUs |

The following illustration shows those options included in this programming group.

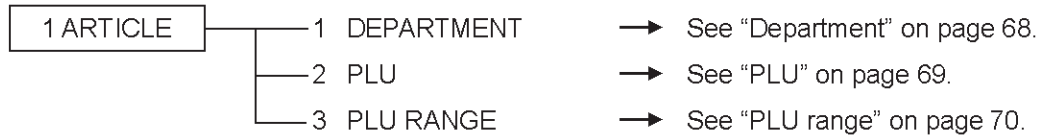

■ Department

The register can be equipped with maximum of 99 departments.
Use the following procedure to program for department.

NOTE To delete a department item in the "DEPARTMENT" window, select the item and press the **[DEL]** key. A confirmation window appears to ask you whether to delete the item, select the option you prefer.

Procedure

Select a pertinent dept. code from the departments list.



| | | |
|----|-------|----------|
| 01 | PRICE | 0.00 |
| | | DPT. 01 |
| | | OPEN YES |
| | | TAX1 NO |
| | | TAX2 NO |
| | | TAX3 NO |
| | | PGM 01 |

The screen continues.

Program each item as follows:

NOTE For more information about the entry patterns, see the "Basic Instructions" section.

- **PRICE (Use the numeric entry)**
Unit price (max. 8 digits)
- **Description (Use the character entry)**
Description for a department. Up to 16 characters can be entered. (Default text: DPT.nn)
- **TYPE (Use the selective entry)**
Type of unit price entry for departments
INHIBIT: Inhibited
OPEN: Open only
PRESET: Preset only
OPEN & PRESET: Open & preset

- **TAX1 through 4 (Use the selective entry)**
Taxability
YES : Taxable
NO : Non-taxable

NOTE The tax system of your register has been factory-set to automatic VAT1 - 4.

- **SICS (Use the selective entry)**
YES: SICS department
NO: Normal department
- **GROUP No. (Use the numeric entry)**
01-09: Plus department
10: Minus department
11: Plus hash department
12: Minus hash department

- **HALO (Use the numeric entry)**
This function is intended for prevention of accidentally entered unreasonably amounts.
Limit amount: 0.00 to 999999.99

NOTE In the initial programming, the HALO function is programmed as "INVALID".

■ PLU

NOTE To delete a PLU item in the "PLU" window, select the item and press the **DEL** key. A confirmation window appears to ask you whether to delete the item, select the option you prefer.

Procedure

Select a pertinent PLU code.



| | |
|-------------|----------|
| 00001 | |
| PRICE | 0.00 |
| TYPE | PLU00001 |
| DEPT . CODE | PRESET |
| | 01 |
| PGM | 01 |

Program each item as follows:

- **PRICE (Use the numeric entry)**

Unit price of each price level (max. 8 digits)

- **Description (Use the character entry)**

Description for a PLU. Up to 16 characters can be entered.
(Default text: PLUnnnnn)

- **TYPE (Use the selective entry)**

Type of unit price entry for PLU

INHIBIT: Inhibited

OPEN: Open only

PRESET: Preset only

OPEN & PRESET: Open & preset

- **DEPT. CODE (Use the numeric entry)**

Department code to be associated with the entered PLU

(01 through 99)

When a PLU is associated with a department, the following functions of the PLU depend on the programming for the department.

- Grouping (group 1 through 12)
- Single item cash sale
- HALO (only for subdepartments)
- Taxability

■ PLU range

You can program PLUs in the designated range.

Procedure

```
PLU RANGE
START      00000
END        00000
OPERATIONNEW&MAINT.
PGM                               01
```



```
00001-00010
PRICE
TYPE
DEPT . CODE
PGM                               01
```

Enter a value or select an option for each item as follows:

- **START (Use the numeric entry)**

Starting PLU code (max. 5 digits)

- **END (Use the numeric entry)**

Ending PLU code (max. 5 digits)

- **OPERATION (Use the selective entry)**

DELETE: Enables you to delete a specified range of PLUs.

MAINT.: Enables you to change the setting you have programmed.

NEW&MAINT.: Enables you to change the current setting when the specified codes have already been created or to create new codes when the specified codes have not been created yet.

Functional Programming

Use the following procedure to select any option included in the functional programming group:

Procedure

```

SETTING
1 ARTICLE
2 FUNCTIONS
3 MEDIA
4 FUNCTION TEXT
5 PERSONNEL
PGM 01
    
```



```

FUNCTIONS
1 (-)
2 %1
3 %2
4 ***RA
5 ***PO
PGM 01
    
```

The screen continues.

1. In the SETTING window, select "2 FUNCTIONS."
 - The FUNCTIONS window will appear.

2. Select any option from the following options list.

| | | |
|---|---------|---------------------|
| 1 | (-) | Discount |
| 2 | %1 | Percent 1 |
| 3 | %2 | Percent 2 |
| 4 | ***RA | Received on account |
| 5 | ***PO | Paid out |
| 6 | ****CID | Cash in drawer |
| 7 | CHK/CG | Check change |
| 8 | CA/CHK | Check cashing |

The following illustration shows those options included in this programming group.

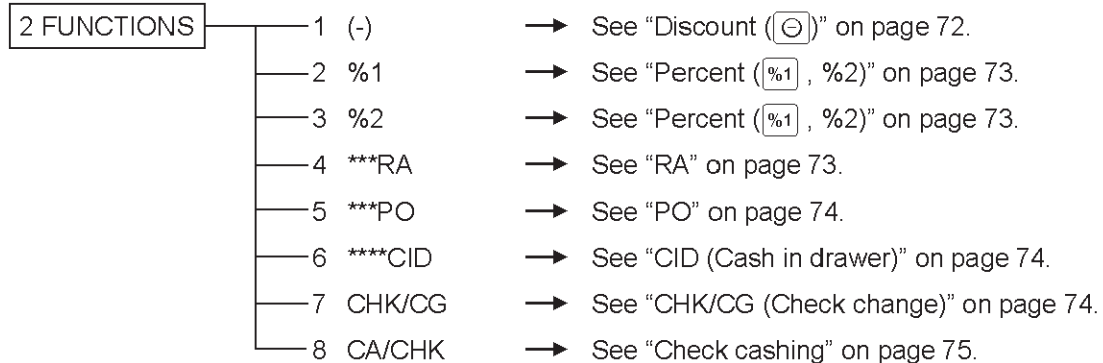

■ Discount (☉)

Procedure

| | |
|----------|-----------|
| < — > | |
| AMOUNT | —0.00 |
| TEXT | < — > |
| SIGN | - |
| HALO | 999999.99 |
| ITEM | YES |
| SUBTOTAL | YES |
| PGM | 01 |

Program each item as follows:

- **AMOUNT (Use the numeric entry)**
Discount amount (max. 8 digits)
- **TEXT (Use the character entry)**
Description for the discount key. Up to 12 characters can be entered.
- **SIGN (Use the selective entry)**
Programming of the + or - sign assigns the premium or discount function to each discount key.
+: Plus amount (premium)
-: Minus amount (discount)
- **HALO (High Amount Lockout) (Use the numeric entry)**
This function is intended for prevention of accidentally entered unreasonably amounts.
Limit amount: 0.00 to 999999.99

NOTE

In the initial programming, the HALO function is programmed as "INVALID".

- **ITEM (Use the selective entry)**
YES: Enables the item discount.
NO: Disables the item discount.
- **SUBTOTAL (Used the selective entry)**
YES: Enables the subtotal discount.
NO: Disables the subtotal discount.

■ Percent (%1 , %2)

Procedure

```

/ 1
RATE          -0.00%
TEXT          / 1
SIGN          -
HALO          100.00%
ITEM          NO
SUBTOTAL     YES
PGM          01
  
```

Program each item as follows:

- **RATE (Use the numeric entry)**
Percent rate (0.00 to 100.00)
- **TEXT (Use the character entry)**
Description for the percent key. Up to 12 characters can be entered.
- **SIGN (Use the selective entry)**
Programming of the + or - sign assigns the premium or discount function to each percent key.
+: Plus (premium)
-: Minus (discount)
- **HALO (High Amount Lockout) (Use the numeric entry)**
This function is intended for prevention of accidentally entered unreasonably amounts.
HALO (High Amount Lockout) for the percent key (0.00 to 100.00)

NOTE

In the initial programming, the HALO function is programmed as "INVALID".

- **ITEM (Use the selective entry)**
YES: Enables the item %.
NO: Disables the item %.
- **SUBTOTAL (Used the selective entry)**
YES: Enables the subtotal %.
NO: Disables the subtotal %.

■ RA

You can program an upper limit amount and description for received-on-account key.

Procedure

```

XXXXRA
HALO          9999999.99
TEXT          XXXXRA
PGM          01
  
```

Program each item as follows:

- **HALO (High Amount Lockout) (Use the numeric entry)**
This function is intended for prevention of accidentally entered unreasonably amounts.
Limit amount: 0.00 to 9999999.99

NOTE

In the initial programming, the HALO function is programmed as "INVALID".

- **TEXT (Use the character entry)**
Description for the received-on-account key. Up to 12 characters can be entered.

■ PO

You can program an upper limit amount and description for paid-out key.

Procedure

```
***PO
HALO      99999999.99
TEXT      ***PO

PGM                               01
```

Program each item as follows:

- **HALO (High Amount Lockout) (Use the numeric entry)**

This function is intended for prevention of accidentally entered unreasonably amounts.

Limit amount: 0.00 to 9999999.99

NOTE

In the initial programming, the HALO function is programmed as "INVALID".

- **TEXT (Use the character entry)**

Description for the paid-out key. Up to 12 characters can be entered.

■ CID (Cash in drawer)

You can program the description and the upper limit amounts for cash in drawer (sentinel).

Procedure

```
CID
HALO      99999999.99
TEXT      ***CID

PGM                               01
```

Program each item as follows:

- **HALO (High Amount Lockout) (Use the numeric entry)**

This function is intended for prevention of accidentally entered unreasonably amounts.

Limit amount: 0.00 to 99999999.99

NOTE

In the initial programming, the HALO function is programmed as "INVALID".

When the cash in drawer amounts exceeds a limit amount, the sentinel mark(X) will be displayed.

- **TEXT (Use the character entry)**

Description for the cash in drawer. Up to 12 characters can be entered.

■ CHK/CG (Check change)

You can program the description and the upper limit amounts for check change.

Procedure

```
CHK/CG
HALO      999999.99
TEXT      CHK/CG

PGM                               01
```

Program each item as follows:

- **HALO (High Amount Lockout) (Use the numeric entry)**

This function is intended for prevention of accidentally entered unreasonably amounts.

Limit amount: 0.00 to 999999.99

NOTE

In the initial programming, the HALO function is programmed as "INVALID".

- **TEXT (Use the character entry)**

Description for check change. Up to 12 characters can be entered.

■ Check cashing

You can program the description and the upper limit amounts for check cashing.

Procedure

| | |
|--------|-----------|
| CA/CHK | 999999.99 |
| HALO | CA/CHK |
| TEXT | |
| PGM | 01 |

Program each item as follows:

- **HALO (High Amount Lockout) (Use the numeric entry)**

This function is intended for prevention of accidentally entered unreasonably amounts.

Limit amount: 0.00 to 999999.99

NOTE

In the initial programming, the HALO function is programmed as "INVALID".

- **TEXT (Use the character entry)**

Description for check cashing. Up to 12 characters can be entered.

Media Key Programming

Use the following procedure to select any option included in the media group:

Procedure

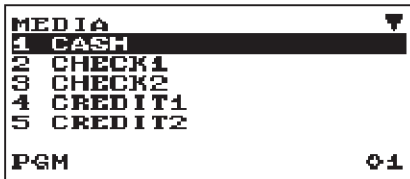
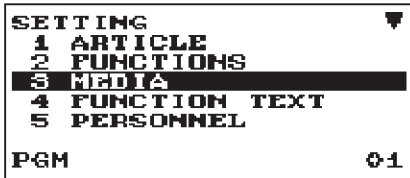

The screen continues.

1. In the SETTING window, select "3 MEDIA."
 - The MEDIA window will appear.

2. Select any option from the following options list.

| | |
|--------------------|------------------|
| 1 CASH | Cash |
| 2 CHECK1 | Check1 key |
| 3 CHECK2 | Check2 |
| 4 CREDIT1 | Credit1 key |
| 5 CREDIT2 | Credit2 |
| 6 FOREIGN CURRENCY | Foreign Currency |

The following illustration shows those options included in this programming group.

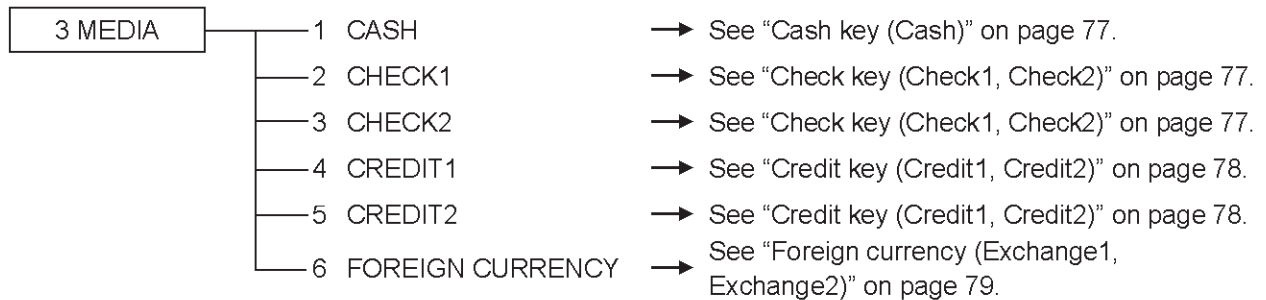

■ Cash key (Cash)

Procedure

```
CASH
TEXT      ██████████ CASH
HALO      999999.99
FOOTER PRINT NO
TEND .    NON-COMPUL .

PGM      A      01
```

Program each item as follows:

- **TEXT (Use the character entry)**
Description for the cash key. Up to 12 characters can be entered.
- **HALO (High Amount Lockout) (Use the numeric entry)**
This function is intended for prevention of accidentally entered unreasonably amounts.
Limit amount: 0.00 to 999999.99

NOTE

In the initial programming, the HALO function is programmed as "INVALID".

- **FOOTER PRINT (Use the selective entry)**
This item decides whether or not your register should print a message at the foot of a receipt when a specified cash key is used.
YES: Enables footer printing on the receipt.
NO: Disables footer printing on the receipt.
- **TEND. (Use the selective entry)**
NON-COMPUL.: Non-compulsory amount tendered entry.
COMPULSORY: Compulsory amount tendered entry.

■ Check key (Check1, Check2)

Procedure

```
CHECK1
TEXT      ██████████ CHECK1
HALO      999999.99
FOOTER PRINT NO
TEND .    NON-COMPUL .

PGM      A      01
```

Program each item as follows:

- **TEXT (Use the character entry)**
Description for the check key. Up to 12 characters can be entered.
- **HALO (High Amount Lockout) (Use the numeric entry)**
This function is intended for prevention of accidentally entered unreasonably amounts.
Limit amount: 0.00 to 999999.99

NOTE

In the initial programming, the HALO function is programmed as "INVALID".

- **FOOTER PRINT (Use the selective entry)**
YES: Enables footer printing on the receipt.
NO: Disables footer printing on the receipt.
- **TEND. (Use the selective entry)**
NON-COMPUL.: Non-compulsory amount tendered entry.
COMPULSORY: Compulsory amount tendered entry.

■ Credit key (Credit1, Credit2)

Procedure

```
CREDIT1  
TEXT      CREDIT1  
HALO      999999.99  
FOOTER PRINT NO  
TEND.     INHIBITED  
  
PGM      A      01
```

Program each item as follows:

- **TEXT (Use the character entry)**

Description for the credit key. Up to 12 characters can be entered.

- **HALO (High Amount Lockout) (Use the numeric entry)**

This function is intended for prevention of accidentally entered unreasonably amounts.

Limit amount: 0.00 to 999999.99

NOTE

In the initial programming, the HALO function is programmed as "INVALID".

- **FOOTER PRINT (Use the selective entry)**

This item decides whether or not your register should print a message at the foot of a receipt when a specified credit key is used.

YES: Enables footer printing on the receipt.

NO: Disables footer printing on the receipt.

- **TEND. (Use the selective entry)**

COMPULSORY: Compulsory amount tendered entry.

INHIBITED: Inhibits amount tendered entry.

Foreign currency (Exchange1, Exchange2)

Procedure

```

FOREIGN CURRENCY  F
PRESET RATE      ENABLE
RATE             0.000000
TEXT             EXCH1
SYMBOL
TAB              2
OPEN RATE       ENABLE
PGM              01
    
```

The screen continues.

Program each item as follows:

- **PRESET RATE (Use the selective entry)**
 ENABLE: Enables preset rate
 DISABLE: Disable preset rate
- **RATE (Use the numeric entry)**
 Currency exchange rate (0.000000 to 999.999999)
- **TEXT (Use the character entry)**
 Description for the currency exchange key. Up to 12 characters can be entered.
- **SYMBOL (Use the character entry)**
 Currency descriptor. Up to 4 characters can be entered.
- **TAB (Use the selective entry)**
 Tabulation (0 to 3)
- **OPEN RATE (Use the selective entry)**
 ENABLE: Enables open rate
 DISABLE: Disable open rate
- **TEXT (Use the character entry) for open rate**
 Description for the currency exchange key for open rate. Up to 12 characters can be entered.
- **SYMBOL (Use the character entry) for open rate**
 Currency descriptor for open rate. Up to 4 characters can be entered.
- **TAB (Use the selective entry) for open rate**
 Tabulation for open rate (0 to 3)

NOTE

Currency symbol is printed with (+) amount of foreign currency.
 The programmed character is printed at left side of amount.

EX) Case of "DM":

| | |
|-------|----------|
| EXCH1 | 1.234567 |
| | DM 1.23 |

↑
 Programmed symbol

Function Text Programming

You can program a maximum of 12 characters for each function by using the following table:

Procedure

| | |
|------------------------|----|
| SETTING | |
| 1 ARTICLE | |
| 2 FUNCTIONS | |
| 3 MEDIA | |
| 4 FUNCTION TEXT | |
| 5 PERSONNEL | |
| PGM | 01 |



| | |
|---------------|----|
| FUNCTION TEXT | |
| 1 NET1 | |
| 2 DIFFER | |
| 3 TAX1 ST | |
| 4 TAX2 ST | |
| 5 TAX3 ST | |
| PGM | 01 |

The screen continues.

- In the SETTING window, select "4 FUNCTION TEXT".
 - The FUNCTION TEXT window will appear.

- Program each item as follows:

- Text (Use the character entry)**

Description for each function. Up to 12 characters can be entered.

List of function text

| No. | Function | Default text |
|-----|-----------------------------|--------------|
| 1 | Net 1 | NET1 |
| 2 | Difference | DIFFER |
| 3 | Taxable 1 subtotal | TAX1 ST |
| 4 | Taxable 2 subtotal | TAX2 ST |
| 5 | Taxable 3 subtotal | TAX3 ST |
| 6 | Taxable 4 subtotal | TAX4 ST |
| 7 | VAT/tax 1 | VAT 1 |
| 8 | VAT/tax 2 | VAT 2 |
| 9 | VAT/tax 3 | VAT 3 |
| 10 | VAT/tax 4 | VAT 4 |
| 11 | Total tax (on report) | TTL TAX |
| 12 | Net without tax (on report) | NET |
| 13 | Net 2 | NET2 |
| 14 | Refund | REFUND |
| 15 | Void | VOID |
| 16 | Void mode | VOID MODE |
| 17 | MGR void | MGR VOID |
| 18 | Subtotal void | SBTL VOID |
| 19 | Hash void | HASH VOID |
| 20 | Hash refund | HASH RF |
| 21 | Bill counter | BILL CNT |
| 22 | No sale | NO SALE |
| 23 | Starting cash memory (+) | SCM(+) |
| 24 | Starting cash memory (-) | SCM(-) |

| No. | Function | Default text |
|-----|------------------------------------|--------------|
| 25 | Guest (customer/transaction count) | GUEST |
| 26 | Paid total | PAID TL |
| 27 | Average | AVE. |
| 28 | Check payment for exchange 1 | EX1 CHK |
| 29 | Credit payment for exchange 1 | EX1 CR |
| 30 | Domestic currency 1 | DOM.CUR1 |
| 31 | Domestic currency 2 | DOM.CUR2 |
| 32 | Domestic currency 1 for check | DOM.CUR1CHK |
| 33 | Domestic currency 1 for credit | DOM.CUR1CR |
| 34 | Check in drawer | *CH ID |
| 35 | Cash/check in drawer | CA/CHK ID |
| 36 | Group 1 | GROUP01 |
| 37 | Group 2 | GROUP02 |
| 38 | Group 3 | GROUP03 |
| 39 | Group 4 | GROUP04 |
| 40 | Group 5 | GROUP05 |
| 41 | Group 6 | GROUP06 |
| 42 | Group 7 | GROUP07 |
| 43 | Group 8 | GROUP08 |
| 44 | Group 9 | GROUP09 |
| 45 | (+)dept. total | *DEPT TL |
| 46 | (-)dept. total | DEPT(-) |
| 47 | Hash(+) total | *HASH TL |
| 48 | Hash(-) total | *HASH(-) |

| No. | Function | Default text |
|-----|-------------------------------|--------------|
| 49 | Total | ***TOTAL |
| 50 | Subtotal | SUBTOTAL |
| 51 | Starting cash memory total | SCM TTL |
| 52 | Non-add code text | # |
| 53 | Sales q'ty | ITEMS |
| 54 | Merchandise subtotal | MDSE ST |
| 55 | Net 1 (Taxable 1 - VAT/tax 1) | NET 1 |
| 56 | Net 2 (Taxable 2 - VAT/tax 2) | NET 2 |
| 57 | Net 3 (Taxable 3 - VAT/tax 3) | NET 3 |
| 58 | Net 4 (Taxable 4 - VAT/tax 4) | NET 4 |
| 59 | Due (on display) | DUE |
| 60 | Change | CHANGE |
| 61 | Copy receipt title | COPY |

| No. | Function | Default text |
|-----|--|--------------|
| 62 | Guest check receipt title | BILL |
| 63 | Receipt switch | RCP SW. |
| 64 | VAT shift (XE-A217 only) | VAT SFT |
| 65 | VAT/tax delete (XE-A217 only) | TAX DELE |
| 66 | PBAL (for GLU) (XE-A217 only) | ***PBAL |
| 67 | NBAL (for GLU) (XE-A217 only) | ***NBAL |
| 68 | Order total (for GLU) (XE-A217 only) | ORDER TL |
| 69 | Order total - Paid total (for GLU) (XE-A217 only) | O - P |
| 70 | Old balance (XE-A217 only) | OLD BAL. |
| 71 | New balance (XE-A217 only) | BALANCE |
| 72 | GLU code text (XE-A217 only) | GLU# |

Personnel Programming

Use the following procedure to select any option included in the personnel group:

Procedure

```

SETTING          ▼
1 ARTICLE
2 FUNCTIONS
3 MEDIA
4 FUNCTION TEXT
5 PERSONNEL
PGM              01
    
```



```

PERSONNEL
1 CLERK
2 MANAGER
3 MODE PASS CODE
4 TRAINING CLK
PGM              01
    
```

1. In the SETTING window, select "5 PERSONNEL."
 • The PERSONNEL window will appear.

2. Select any option from the following options list.

| | | |
|---|----------------|----------------|
| 1 | CLERK | Clerk |
| 2 | MANAGER | Manager |
| 3 | MODE PASS CODE | Mode Pass Code |
| 4 | TRAINING CLK | Training Clerk |

The following illustration shows those options included in this programming group.

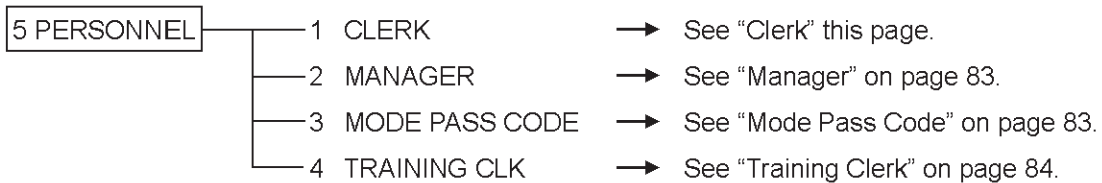

■ Clerk

Procedure

```

CLERK
01 CLERK01
02 CLERK02
03 CLERK03
04 CLERK04
PGM              01
    
```



```

01 PASS CODE      0000
   AUTO KEY      CLERK01
                   ENABLE
PGM              01
    
```

NOTE

- To create additional clerks enter the clerk number 5 - 25 in the clerk selection window "CLERK".
- To delete a clerk code in the "CLERK" window, select the clerk code and press the **DEL** key. A confirmation window appears to ask you whether to delete the clerk, select the option you prefer.

Program each item as follows:

• PASS CODE (Use the numeric entry)

Pass code (max. 4 digits: 0001 to 9999/0000)

• Text (Use the character entry)

Description for the clerk name (Up to 16 characters can be entered.)

• AUTO KEY (Use the selective entry)

ENABLE: Enables operation of the **AUTO MENU** key.

DISABLE: Disables operation of the **AUTO MENU** key.

■ Manager

You can program a secret code for manager.

Procedure

```
MANAGER
PASS CODE 0000
PGM 01
```

Program each item as follows:

- **PASS CODE (Use the numeric entry)**
Pass code (max. 4 digits: 0000 to 9999)

■ Mode Pass Code

You can program a secret code for each mode.

Procedure

```
MODE PASS CODE 0000
VOID MODE
OPXZ 0000
FLASH 0000
X1 0000
Z1 0000
X2Z2 0000
PGM 01
```

The screen continues.

Program each item as follows:

- **VOID MODE (Use the numeric entry)**
Pass code (max 4 digits: 0000 to 9999)
- **OPXZ (Use the numeric entry)**
Pass code (max 4 digits: 0000 to 9999)
- **FLASH (Use the numeric entry)**
Pass code (max 4 digits: 0000 to 9999)
- **X1 (Use the numeric entry)**
Pass code (max 4 digits: 0000 to 9999)
- **Z1 (Use the numeric entry)**
Pass code (max 4 digits: 0000 to 9999)
- **X2Z2 (Use the numeric entry)**
Pass code (max 4 digits: 0000 to 9999)
- **PGM (Use the numeric entry)**
Pass code (max 4 digits: 0000 to 9999)
- **SD CARD (Use the numeric entry)**
Pass code (max 4 digits: 0000 to 9999)

■ Training Clerk

You can set the training clerk code and text for the training mode title.

Procedure

| | |
|---------------------|-----------------|
| TRAINING CLK | |
| CODE | 00 |
| TEXT | TRAINING |
| PGM | 01 |

Program each item as follows:

- **CODE (Use the numeric entry)**

Clerk code in training (max. 2 digits: 00 to 25)

- **TEXT (Use the character entry)**

Description for the training mode title (Up to 12 characters can be entered.)

Terminal Programming

Use the following procedure to select any option included in the terminal group:

Procedure

```
SETTING ▲▼
6 TERMINAL
7 DATE/TIME
8 OPTIONAL
9 REPORT
10 MESSAGE
PGM 01
```



```
TERMINAL
MACHINE# 000000
CONSECUTIVE# 000000
GT2 0.00
GT3 0.00
PGM 01
```

1. In the SETTING windows, select "6 TERMINAL."
 - The TERMINAL windows will appear.

2. Select any option from the following options list:

- **MACHINE# (Use the numeric entry)**
Machine number (max. 6 digits: 0 to 999999)
- **CONSECUTIVE# (Use the numeric entry)**
Enter a number (max. 6 digits: 0 to 999999) that is the desired starting number.
- **GT2: (Use the numeric entry)**
Enter a number (max. 13 digits: 0 to 9999999999999)
- **GT3: (Use the numeric entry)**
Enter a number (max. 13 digits: 0 to 9999999999999)

Date/Time Setting

You can set the date and time for the register.

■ Date/time

Procedure

```
SETTING          ▲▼
 6 TERMINAL
 7 DATE/TIME
 8 OPTIONAL
 9 REPORT
10 MESSAGE
PGM              01
```



```
DATE/TIME
DATE          01/01/2011
TIME          0000
PGM              01
```

1. In the SETTING window, select "7 DATE/TIME".
 - The DATE/TIME window will appear.

2. Set each item as follows:

- **DATE (Use the numeric entry)**

Enter the day (2 digits), month (2 digits), and year (2 digits) in this sequence.

- **TIME (Use the numeric entry)**

Set the time (max. 4 digits) on the 24-hour system. For example, when the time is set to 2:30 AM, enter 0230; and when it is set to 2:30 PM, enter 1430. The time will be printed and displayed.

Optional Feature Selection

Use the following procedure to select any option included in the optional group:

Procedure

```

SETTING          ▲▼
6 TERMINAL
7 DATE/TIME
8 OPTIONAL
9 REPORT
10 MESSAGE
PGM              ⓪1
    
```



```

OPTIONAL        ▼
1 BASIC SYSTEM
2 ROUNDING
3 FUNC. PROHIBIT
4 FUNC. AUTHORITY
5 FUNCTION SELECT
PGM              ⓪1
    
```

The screen continues.

1. In the SETTING window, select "8 OPTIONAL."
 - The OPTIONAL window will appear.

2. Select any option from the following options list.

| | | |
|---|-------------------|---------------------|
| 1 | BASIC SYSTEM | Basic system |
| 2 | ROUNDING | Rounding |
| 3 | FUNC. PROHIBIT | Function prohibited |
| 4 | FUNC. AUTHORITY | Function authority |
| 5 | FUNCTION SELECT | Function selection |
| 6 | PRINT SELECT | Print selection |
| 7 | EXCHANGE FUNCTION | Exchange function |
| 8 | EURO CHANGE | Euro change |

The following illustration shows those options included in this programming group.

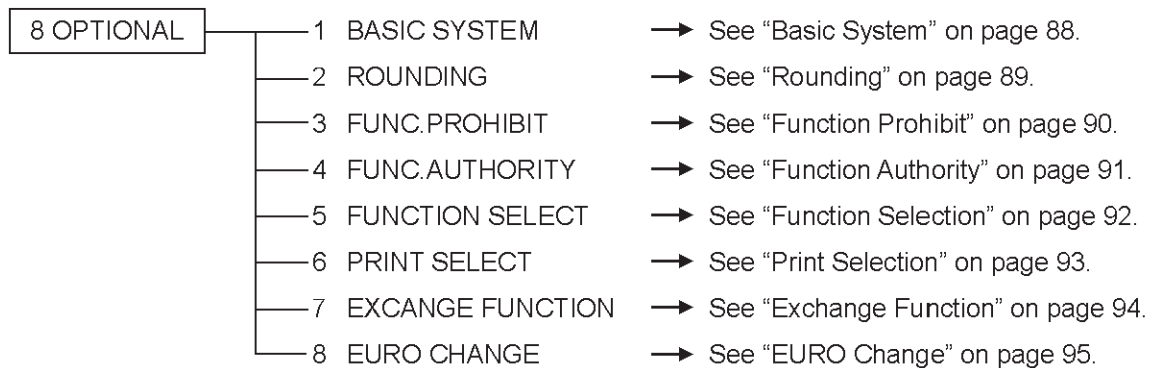

■ Basic System

Your register allows you to select various item of basic system.

Procedure

```

BASIC SYSTEM          7
DATE FORMAT          010
TIME FORMAT      24-HOUR
ERROR      LOCK ERROR *
CURRENCY SYMBOL      *
TAB                2
DECIMAL QUANTITY YES
P&M                01
  
```

The screen continues.

Program each item as follows:

- **DATE FORMAT (Use the selective entry)**
 - MDY: Display and print the month, day, and year in this order
 - DMY: Display and print the day, month and year in this order
 - YMD: Display and print the year, month, and day in this order
- **TIME FORMAT (Use the selective entry)**
 - 12-HOUR: Display and print the time on 12-hour system
 - 24-HOUR: Display and print the time on 24-hour system
- **ERROR (Use the selective entry)**
 - Response to an erroneous, invalid key operation
 - LOCK ERROR: Sound a short buzzer for 2 seconds, and display Error. To hide the Error display, press the **CL** key.
 - MISS OPE.: Sound a short buzzer
- **CURRENCY SYMBOL (Use the character entry)**
 - Enter the character (Max. 4 characters)
- **TAB (Use the selective entry)**
 - 0 } Position of price delimiter can be set. Setting options are 0, 1, 2, and 3.
 - 1 }
 - 2 } When setting to "2" for example, the entry of "100" is displayed as "1.00".
 - 3 }
- **DECIMAL QUANTITY (Use the selective entry)**
 - YES: Enable to enter the decimal quantity
 - NO: Disable to enter the decimal quantity
- **DECIMAL ROUND (Use the selective entry)**
 - ROUND: Round off the number
 - UP: Round up after the decimal point
 - DOWN: Round down after the decimal point.
- **HALO FUNC. (Use the selective entry)**
 - VALID: Valid HALO function
 - INVALID: Invalid HALO function
- **[00] KEY (Use the selective entry)**
 - [00]: Display [00] by pressing the **00** key
 - [000]: Display [000] by pressing the **00** key
- **PRT/DSP EDIT (Use the selective entry)**
 - YES: All of printing and display are edited
 - NO: All of printing and display aren't edited
- **ITEM DISPLAY (Use the selective entry)**
 - 2-LINE: The 1st line displays the quantity, price and amount. The 2nd line displays the text.
 - 1-LINE: The quantity and text.

■ Rounding

Your register allows you to select various item of rounding system.

Procedure

```

ROUNDING          ▾
ROUND100         NORMAL
ROUND10          00
ROUND FOR ITEM&TOTAL
CH/CR ROUND     YES
ROUND PRINT      NO
DIFFER MEMORY   NO
P&M             01
  
```

The screen continues.

Program each item as follows:

• ROUND 100 (Use the selective entry)

Rounding system selection

NORMAL: Minimum rounding currency unit is 1 (1 cent)

25: Minimum rounding currency unit is 25 (25 cents)

50: Minimum rounding currency unit is 50 (50 cents)

100: Minimum rounding currency unit is 100 (ex: 1 Swedish Krona)

• ROUND 10 (Use the numeric entry)

Rounding up/down of the units digit of amount.

Enter a number (2 digits 00 to 99)

• ROUND FOR (Use the selective entry)

ITEM&TOTAL: Rounding of the item and total

TOTAL: Rounding of the total

• CH/CR ROUND (Use the selective entry)

This selection is not effective at Manual TAX1-4 system.

YES: Enable the Australian rounding

NO: Disable the Australian rounding

• ROUND PRINT (Use the selective entry)

YES: Print the rounding amount

NO: Not print the rounding amount

• DIFFER MEMORY (Use the selective entry)

YES: Memory the difference between before-rounding and after-rounding

NO: No memory the difference between before-rounding and after-rounding

• ITEM ENT (Use the selective entry)

Limit on the least significant digit in entering the amount of item

ANY: No limit at the least significant digit in each amount entry

0 ONLY: Limit to 0 at the least significant digit in each amount entry

0.5 ONLY: Limit to 0.5 at the least significant digit in each amount entry

• PAYMENT ENT (Use the selective entry)

Limit on the least significant digit in entering the amount of payment

ANY: No limit at the least significant digit in each amount entry

0 ONLY: Limit to 0 at the least significant digit in each amount entry

0.5 ONLY: Limit to 0.5 at the least significant digit in each amount entry

■ Function Prohibit

Your register allows you to select whether to enable or disable various functions.

Procedure

| | |
|-----------------------|---------------|
| FUNC. PROHIBIT | ENABLE |
| NON-ADD | ENABLE |
| NON-ADD + NS | ENABLE |
| MINUS DEPT | ENABLE |
| HASH DEPT | ENABLE |
| COPY RCPT | ENABLE |
| VOID MODE | ENABLE |
| P&M | 01 |

The screen continues.

Program each item as follows:

- **NON-ADD (Use the selective entry)**
 - ENABLE: Enable to enter Non-add code
 - DISABLE: Disable to enter Non-add code
- **NON-ADD + NS (Use the selective entry)**
 - ENABLE: Enable No sale after Non-add code entry
 - DISABLE: Disable No sale after Non-add code entry
- **MINUS DEPT (Use the selective entry)**
 - ENABLE: Enable to enter the minus department or PLU
 - DISABLE: Disable to enter the minus department or PLU
- **HASH DEPT (Use the selective entry)**
 - ENABLE: Enable to enter the hash department or PLU
 - DISABLE: Disable to enter the hash department or PLU
- **COPY RCPT (Use the selective entry)**
 - ENABLE: Enable the receipt copy function
 - DISABLE: Disable the receipt copy function
- **VOID MODE (Use the selective entry)**
 - ENABLE: Enable the void mode
 - DISABLE: Disable the void mode
- **SUBTOTAL<0 (Use the selective entry)**
 - ENABLE: Enable to go negative merchandise subtotal
 - DISABLE: Disable to go negative merchandise subtotal
- **TEND+DIRECT (Use the selective entry)**
 - ENABLE: Enable the direct non-tendering finalization after the previous tender entry
 - DISABLE: Disable the direct non-tendering finalization after the previous tender entry

■ Function Authority

Your register allows you to select whether to public or to limit function authority.

Procedure

```
FUNC . AUTHORITY  PUBLIC
RA                PUBLIC
PO                PUBLIC
REFUND           PUBLIC
NO ISSUED VD     PUBLIC
ISSUED VD        PUBLIC
SBTL VD          PUBLIC
P&M              01
```

The screen continues.
(XE-A217W/XE-A217B only)

Program each item as follows:

- **RA (Use the selective entry)**
 - LIMITED: Allowed only in the Manager mode.
 - PUBLIC: Allowed in the REG mode and the Manager mode.
- **PO (Use the selective entry)**
 - LIMITED: Allowed only in the Manager mode.
 - PUBLIC: Allowed in the REG mode and the Manager mode.
- **REFUND (Use the selective entry)**
 - LIMITED: Allowed only in the Manager mode.
 - PUBLIC: Allowed in the REG mode and the Manager mode.
- **ITEM VD (Use the selective entry) for XE-A207W/XE-A207B only**
 - LIMITED: Allowed only in the Manager mode.
 - PUBLIC: Allowed in the REG mode and the Manager mode.
- **NO ISSUED VD (Use the selective entry) for XE-A217W/XE-A217B only**
 - LIMITED: Allowed only in the Manager mode. (for GLU registration)
 - PUBLIC: Allowed in the REG mode and the Manager mode. (for GLU registration)
- **ISSUED VD (Use the selective entry) for XE-A217W/XE-A217B only**
 - LIMITED: Allowed only in the Manager mode. (for GLU registration)
 - PUBLIC: Allowed in the REG mode and the Manager mode. (for GLU registration)
- **SBTL VD (Use the selective entry)**
 - LIMITED: Allowed only in the Manager mode.
 - PUBLIC: Allowed in the REG mode and the Manager mode.
- **NO SALE (Use the selective entry)**
 - LIMITED: Allowed only in the Manager mode.
 - PUBLIC: Allowed in the REG mode and the Manager mode.

■ Function Selection

Your register enables you to select various functional selections.

Procedure

```

FUNCTION SELECT  ▾
LV.SFT MODE     PUBLIC
LV.SFT TYPE     AUTO
RETURN TO L1 RECEIPT
GLU# ENTRY     AUTO
GLU CLK CHECK   NO
SPLIT COUNT QUANTITY
PGM             01
  
```

The screen continues.

Program each item as follows:

- **LV.SFT MODE (Use the selective entry) for XE-A217W/XE-A217B only**
 - LIMITED: Allowed only in the Manager mode.
 - PUBLIC: Allowed in the REG mode and the Manager mode.
- **LV.SFT TYPE (Use the selective entry) for XE-A217W/XE-A217B only**
 - AUTO: Automatic return mode
 - MANUAL: Lock shift mode
- **RETURN TO L1 (Use the selective entry) for XE-A217W/XE-A217B only**
 - When the PLU level shift system is set to "AUTO," the PLU level can be returned to level 1 by one of the following methods:
 - BY ITEM: Returns the PLU level to level 1 by one item.
 - RECEIPT: Returns the PLU level to level 1 by one receipt.
- **GLU# ENTRY (Use the selective entry) for XE-A217W/XE-A217B only**
 - AUTO: Assign GLU code in an automatic serial number
 - MANUAL: Require manual GUL code entry
- **GLU CLK CHECK (Use the selective entry) for XE-A217W/XE-A217B only**
 - Checking of the clerk, when GLU reorder is made.
 - YES: Enable to check of the clerk
 - NO: No checking
- **SPLIT COUNT (Use the selective entry)**
 - Count method of split pricing entry.
 - PACKAGE: Unit of the package
 - QUANTITY: Quantity
- **CR IN RA/PO (Use the selective entry)**
 - Credit totalizer update if RA or PO finalization by the credit key.
 - NON: Not update
 - UPDATE: Update
- **VD MODE TO HOURLY (Use the selective entry)**
 - YES: Enable to add to the hourly total in void mode.
 - NO: Disable to add to the hourly total in void mode.
- **ST BEFORE DIRECT (Use the selective entry)**
 - Subtotal entry before direct non-tendering finalization
 - NOT: Not to require entry of subtotal for the non-tendering finalization
 - MUST: Require entry of subtotal for the non-tendering finalization
- **ST BEFORE TEND (Use the selective entry)**
 - Subtotal entry before tender
 - NOT: Not to require entry of subtotal for the tendering finalization
 - MUST: Require entry of subtotal for the tendering finalization
- **NS RECEIPT (Use the selective entry)**
 - Printing the receipt at the time of No Sale
 - PRINT: Print the receipt
 - NOT: Not to print the receipt

- **RCPT CONTENTS (Use the selective entry)**

TOTAL: Print the total only on the receipt

DETAIL: Print the details on the receipt

- **AFTER TRANS. (Use the selective entry)**

TOTAL: Print the total only on the receipt after finalizing a transaction and the copy receipt

DETAIL: Print the details on the receipt after finalizing a transaction and the copy receipt

- **E.J.FULL (Use the selective entry)**

When the EJ file is full, whether to lock the item entry or not.

LOCK: Lock the item entry

CONTINUE: Not to lock the item entry

■ Print Selection

You can program various printing functions.

Procedure

| | |
|-----------------|-----|
| PRINT SELECT | ▼ |
| CONSECUTIVE NO. | YES |
| DATE | YES |
| TIME | YES |
| PURCHASE NO. | NO |
| TAX STATUS | NO |
| TAXABLE | YES |
| PGM | 01 |

The screen continues.

Program each item as follows:

- **CONSECUTIVE NO. (Use the selective entry)**

YES: Print the consecutive No.

NO: Not to print the consecutive No.

- **DATE (Use the selective entry)**

YES: Print the date

NO: Not to print the date

- **TIME (Use the selective entry)**

YES: Print the time

NO: Not to print the time

- **PURCHASE NO. (Use the selective entry)**

YES: Print the number of the purchase No.

NO: Not to print the number of the purchase No.

- **TAX STATUS (Use the selective entry)**

YES: Print the tax status

NO: Not to print the tax status

- **TAXABLE (Use the selective entry)**

YES: Print the taxable amount

NO: Not to print the taxable amount

- **TAX (Use the selective entry)**

YES: Print the tax amount

NO: Not to print the tax amount

- **TAX (TAXABLE=0) (Use the selective entry)**

YES: Print the tax amount when the taxable amount is zero.

NO: Not to print the tax amount the taxable amount is zero.

- **TAX (TAX=0) (Use the selective entry)**

YES: Print the tax amount when the tax amount is zero.

NO: Not to print the tax amount when the tax amount is zero.

- **NET (Use the selective entry)**

YES: Print the NET amount

NO: Not to print the NET amount

- **SPLIT ENTRY (Use the selective entry)**

A=1st quantity, B=2nd quantity and C=unit price

FORMAT1: A x B/C

FORMAT2: A x C/B

• **ST AT ST KEY (Use the selective entry)**

- YES: Print the subtotal using the ST key
- NO: Not to print the subtotal using the ST key

• **LOGO FORM (Use the selective entry)**

- PATTERN 1: 3 line text header
- PATTERN 2: Image logo header
- PATTERN 3: Image logo header + 3 line text footer
- PATTERN 4: 6 line text header
- PATTERN 5: Image logo header + 3 line text header
- PATTERN 6: 3 line text header + 3 line text footer

• **FOOTER (Use the selective entry)**

- ALL: Print the footer in any media
- BY MEDIA: Print the footer by media

• **0 AMT PLU (Use the selective entry)**

- When the PLU unit price is 0, printing the amount is:
- TEXT ONLY: Print the text only
- NORMAL: Print the price and the text

• **ITEM JOURNAL (Use the selective entry)**

- ALL: Print all items on electronic journal
- SELECT: Print the selected items on electronic journal

• **LOGO ON JOURNAL (Use the selective entry)**

- YES: Print the logo text on electronic journal
- NO: Not to print the logo text on electronic journal

• **BILL ON JOURNAL (Use the selective entry)**

- YES: Print the bill contents on electronic journal
- NO: Not to print the bill contents on electronic journal

■ Exchange Function

Procedure

```
EXCHANGE FUNCTION
PAY FOR EX1      CASH
EX1 CALC.      MULTI
TTL&CHANGE      DOMESTIC
ST SHORT TEND  PRINT

PGM                01
```

Program each item as follows:

• **PAY FOR EX1 (Use the selective entry)**

- Payment for the amount of Exchange 1
- CASH: Payment is made by cash only
- ALL: Payment is made by all media

• **EX1 CALC. (Use the selective entry)**

- Method of the calculation for Exchange 1
- MULTI.: Multiplication
- DIVIDE: Division

• **TTL & CHANGE (Use the selective entry)**

- Print the total and change for the amount of Exchange 1
- DOMESTIC: The domestic item only
- WITH EX1: Print the total and change for the amount of Exchange 1

• **ST SHORT TEND (Use the selective entry)**

- Print the subtotal after Exchange short tendering
- NOT: Not to print the subtotal
- PRINT: Print the subtotal

■ EURO Change

You can program optional functions for EURO change. For the details, refer to EURO Migration Function section.

Procedure

```
EURO CHANGE
DATE          000000
TIME          00
PRICE CONVERT YES
EURO JOB NON-COMPUL.
PGM          01
```

Program each item as follows:

• DATE (Use the numeric entry)

Preset the date to execute the automatic EURO modification operation.

Enter the day (2 digits), month (2 digits), and year (2 digits) in this sequence.

• TIME (Use the numeric entry)

Preset the time of the date to execute the automatic EURO modification operation.

Enter the hour (00-23)

• PRICE CONVERT (Use the selective entry)

YES: Converts the preset unit prices of Dept./PLU in the automatic EURO modification operation.

NO: Does not convert the preset unit prices of Dept./PLU to the ones of EURO currency in the automatic EURO modification operation.

NOTE *The preset rate of the Exchange 1 is applied as the conversion rate, and the calculation method is set to "division".*

• EURO JOB (Use the selective entry)

NON-COMPUL.: Non-compulsory the automatic EURO modification operation in the X2/Z2 mode after the preset date.

COMPULSORY: Compulsory the automatic EURO modification operation in the X2/Z2 mode after the preset date.

NOTE *When the EURO STATUS of your register is already "D" (i.e. the domestic currency has been changed to EURO in your register), this programming is disabled.*

Report Programming

Use the following procedure to select any option included in the report group:

Procedure

```

SETTING          ▲▼
7 DATE/TIME
8 OPTIONAL
9 REPORT
10 MESSAGE
11 DEVICE CONFIG
PGM              ⓪1
    
```



```

REPORT          ▼
1 0 SKIP
2 PRINT SELECT
3 Z COUNTER
4 Z1 GENERAL REPORT
5 HOURLY REPORT
PGM              ⓪1
    
```

The screen continues.

1. In the SETTING window, select "9 REPORT."
 • The REPORT window will appear.

2. Select any option from the following options list:

| | | |
|---|-------------------|--------------------|
| 1 | 0 SKIP | Zero skip |
| 2 | PRINT SELECT | Print select |
| 3 | Z COUNTER | Z counter |
| 4 | Z1 GENERAL REPORT | Z1 General report |
| 5 | HOURLY REPORT | Hourly report |
| 6 | E. JOURNAL | Electronic journal |

The following illustration shows those options included in this programming group.

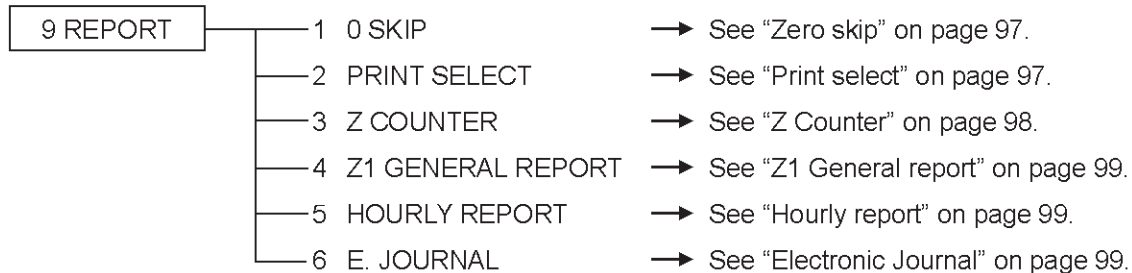

■ Zero skip

You can program whether or not to skip "0" in each report.

Procedure

```

0 SKIP
DEPARTMENT SKIP
TRANSACTION SKIP
PLU SKIP
CLERK SKIP
HOURLY SKIP
PGM 01
  
```

Program each item as follows:

- **DEPARTMENT (Use the selective entry)**

- SKIP: Skips those data that are "0" in the department report.
- NOT SKIP: Does not skip those data that are "0" in the department report.

- **TRANSACTION (Use the selective entry)**

- SKIP: Skips those data that are "0" in the transaction report.
- NOT SKIP: Does not skip those data that are "0" in the transaction report.

- **PLU (Use the selective entry)**

- SKIP: Skips those data that are "0" in the PLU report.
- NOT SKIP: Does not skip those data that are "0" in the PLU report.

- **CLERK (Use the selective entry)**

- SKIP: Skips those data that are "0" in the clerk report.
- NOT SKIP: Does not skip those data that are "0" in the clerk report.

- **HOURLY (Use the selective entry)**

- SKIP: Skips those data that are "0" in the hourly report.
- NOT SKIP: Does not skip those data that are "0" in the hourly report.

■ Print select

You can program whether or not to print the item on the report.

Procedure

```

PRINT SELECT
SEPARATOR LINE YES
Z COUNTER YES
GT1 ON Z YES
GT2 ON Z YES
GT3 ON Z YES
BAL GT ON Z YES
PGM 01
  
```

The screen continues.

Program each item as follows:

- **SEPARATOR LINE (Use the selective entry)**

- YES: Print the separate line on the report.
- NO: Not to print the separate line on the report.

- **Z COUNTER (Use the selective entry)**

- YES: Print the Z counter on the Z report.
- NO: Not to print the Z counter on the Z report.

- **GT1 ON Z (Use the selective entry)**

- YES: Print GT1 on the Z report.
- NO: Not to print GT1 on the Z report.

- **GT2 ON Z (Use the selective entry)**

- YES: Print GT2 on the Z report.
- NO: Not to print GT2 on the Z report.

- **GT3 ON Z (Use the selective entry)**

- YES: Print GT3 on the Z report.
- NO: Not to print GT3 on the Z report.

- **BAL GT ON Z (Use the selective entry) for XE-A217W/XE-A217B only**

- YES: Print the balance GT on the Z report.
- NO: Not to print the balance GT on the Z report.

- **TR GT ON Z (Use the selective entry)**

- YES: Print the training GT on the Z report.
- NO: Not to print the training GT on the Z report.

- **GT1 ON X (Use the selective entry)**
 YES: Print GT1 on the X report.
 NO: Not to print GT1 on the X report.
- **GT2 ON X (Use the selective entry)**
 YES: Print GT2 on the X report.
 NO: Not to print GT2 on the X report.
- **GT3 ON X (Use the selective entry)**
 YES: Print GT3 on the X report.
 NO: Not to print GT3 on the X report.
- **TR GT ON X (Use the selective entry)**
 YES: Print the training GT on the X report.
 NO: Not to print the training GT on the X report.
- **VD MODE ON X1Z1 (Use the selective entry)**
 YES: Print total of VOID MODE on X1Z1 report
 NO: Not to print total of VOID MODE on X1Z1 report
- **VD MODE ON X2Z2 (Use the selective entry)**
 YES: Print total of VOID MODE on X2Z2 report
 NO: Not to print total of VOID MODE on X2Z2 report
- **PLU DATA ON Z (Use the selective entry)**
 YES: Print PLU data on the PLU Z report.
 NO: Not to print PLU data on the PLU Z report.
- **EJ DATA ON Z (Use the selective entry)**
 YES: Print EJ data on the EJ Z report.
 NO: Not to print EJ data on the EJ Z report.
- **EJ SIZE (Use the selective entry)**
 SMALL: Print EJ in a small size.
 NORMAL: Print EJ in a normal size.

■ Z Counter

Procedure

```

Z COUNTER
GENERAL Z1      0001
GENERAL Z2      0001

PGM              01
  
```

Program each item as follows:

- **GENERAL Z1:** Max. 4 digits (0000 to 9999)
- **GENERAL Z2:** Max. 4 digits (0000 to 9999)

■ Z1 General report

Procedure

```
Z1 GENERAL REPORT
SD: SAVE SALES      NO
SD: SAVE EJ        NO
SD: SAVE ALL RAM   NO
CLEAR EJ           NO
RESET BAL GT      NO
RESET GT          NO
PGM                01
```

Program each item as follows:

- **SD: SAVE SALES (Use the selective entry)**
YES: Save the sales data in the SD card.
NO: Not to save the sales data in the SD card.
- **SD: SAVE EJ (Use the selective entry)**
YES: Save the electronic journal data in the SD card.
NO: Not to save the electronic journal data in the SD card.
- **SD: SAVE ALL RAM (Use the selective entry)**
YES: Save all the RAM data in the SD card.
NO: Not to save all the RAM data in the SD card.
- **CLEAR EJ (Use the selective entry)**
YES: Clear the electronic journal data
NO: Not to clear the electronic journal data
- **RESET BAL GT (Use the selective entry) for XE-A217W/XE-A217B only**
YES: Reset the balance GT.
NO: Not to reset the balance GT.
- **RESET GT (Use the selective entry)**
YES: Reset the GT.
NO: Not to reset the GT.

■ Hourly report

You can program the memory type and the starting time for the hourly report.

Procedure

```
HOURLY REPORT
MEMORY TYPE      30MIN
START TIME      00
PGM                01
```

Program each item as follows:

- **MEMORY TYPE (Use the selective entry)**
30MIN: Selects the 30-minute type.
60MIN: Selects the 60-minute type.
- **START TIME (Use the numeric entry)**
Starting time entry (max. 2 digits: 0 to 23)

■ Electronic Journal

Procedure

```
E. JOURNAL
STORE TO SD      W SPACE
TR DATA STORE   YES
X DATA STORE    HEADER
PGM                01
```

Program each item as follows:

- **STORE TO SD (Use the selective entry)**
When the EJ data is recorded on the SD card:
AS IS: Control characters are recorded as they are
W SPACE: Control characters are recorded as double space.
- **TR DATA STORE (Use the selective entry)**
YES: Record the EJ data in the training mode.
NO: Not to record the EJ data in the training mode.
- **X DATA STORE (Use the selective entry)**
When the X report data in the EJ is recorded:
HEADER: Record only the header of X report in the electronic journal.
DETAIL: Record the detail of X report in the electronic journal.

Message Programming

Use the following procedure to select any option included in the message group:

Procedure

```
SETTING          ▲▼
 8 OPTIONAL
 9 REPORT
10 MESSAGE
11 DEVICE CONFIG
12 TAX
PGM              01
```



```
MESSAGE
1 RECEIPT LOGO
PGM              01
```

1. In the SETTING window, select "10 MESSAGE."
 - The MESSAGE window will appear.

2. Select any option from the following options list:

1 RECEIPT LOGO Receipt logo

The following illustration shows those options included in this programming group.



■ Receipt logo

Your register can print programmed messages for customers on every receipt. The logo text is printed in a centering form on the receipt.

Procedure

```
RECEIPT LOGO
THANK YOU
FOR YOUR
PURCHASE
WE ARE LO
FORWARD I
YOUR NEXT
PGM              A 01
```

Program each item as follows:

- **RECEIPT LOGO (Use the character entry)**
Logo text for the receipt (max. 30 characters x 6 lines)

NOTE The programmable number of lines for a message varies according to the following message types:

- PATTERN 1: 3 line text header
- PATTERN 2: Image logo header
- PATTERN 3: Image logo header + 3 line text footer
- PATTERN 4: 6 line text header
- PATTERN 5: Image logo header + 3 line text header
- PATTERN 6: 3 line text header + 3 line text footer

Device Configuration Programming

Use the following procedure to select a device configuration programming:

Procedure

```

SETTING                               ▲▼
8  OPTIONAL
9  REPORT
10 MESSAGE
11 DEVICE CONFIG
12 TAX
PGM                                   ◊1
    
```



```

DEVICE CONFIG
1  KEYBOARD
2  DISPLAY
3  PRINTER
4  ONLINE
PGM                                   ◊1
    
```

1. In the SETTING window, select "11 DEVICE CONFIG."
 - The DEVICE CONFIG window will appear.
2. Select any option from the following options list:

| | | |
|---|----------|----------|
| 1 | KEYBOARD | Keyboard |
| 2 | DISPLAY | Display |
| 3 | PRINTER | Printer |
| 4 | ONLINE | Online |

The following illustration shows those options included in this programming group.

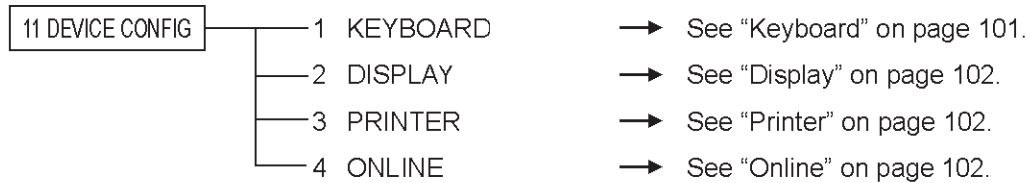

Keyboard

Procedure

```

KEYBOARD
BUFFERING                               YES
TOUCH SOUND                             YES
PGM                                   ◊1
    
```

Program each item as follows:

- **BUFFERING (Use the selective entry)**
 - YES: Enables the buffering keyboard.
 - NO: Disables the buffering keyboard.
- **TOUCH SOUND (Use the selective entry)**
 - YES: Set to sound.
 - NO: Not to sound.

■ Display

Procedure

```

DISPLAY
POWER SAVE          02
P. SAVE AT TM      YES

PGM                  01
  
```

Program each item as follows:

- **POWER SAVE (Use the numeric entry)**
Time of the power save (2 digits: 1 to 99 minutes, 0:100minutes).
- **P. SAVE AT TM (Use the selective entry)**
Power saving during time display:
YES: Enables power saving during time display.
NO: Disables power saving during time display.

■ Printer

Procedure

```

PRINTER
DENSITY             50

PGM                  01
  
```

Program each item as follows:

- **DENSITY (Use the numeric entry)**
Select a density level (2 digits: 00 to 99).
00: 89% for standard
50: 100% for standard
99: 111% for standard

■ Online

Procedure

```

ONLINE
TERMINAL No.       000001
CI SIGNAL          NON
LINE FORM          FULL
BAUD RATE          19200
START CODE         002
END CODE           019
PGM                 01
  
```

The screen continues.

Program each item as follows:

- **TERMINAL No. (Use the numeric entry)**
Terminal number (6 digits: 0 to 999999).
- **CI SIGNAL (Use the selective entry)**
Sensing of the CI signal
NON: Disables sensing of the CI signal.
SENSING: Enables sensing of the CI signal.
- **LINE FORM (Use the selective entry)**
Programming of the modem control
FULL: Full duplex system.
HALF: Half duplex system.
- **BAUD RATE (Use the selective entry)**
Transmission data rate.
38400 bps 19200 bps
9600 bps 4800 bps
- **START CODE (Use the numeric entry)**
Start code (3 digits: 0 to 127)
- **END CODE (Use the numeric entry)**
End code (3 digits: 0 to 127)
- **TIME OUT (Use the numeric entry)**
Programming of the time-out time (3 digits: 1 to 255 sec.)

Tax Programming

Use the following procedure to select any option included in the tax group:

Procedure

```

SETTING          ▲
 9 REPORT
10 MESSAGE
11 DEVICE CONFIG
12 TAX
13 AUTO KEY
PGM              01
    
```



```

TAX
1 TAX SYSTEM
2 TAX1
3 TAX2
4 TAX3
5 TAX4
PGM              01
    
```

1. In the SETTING window, select "12 TAX."
• The TAX window will appear.

2. Select any option from the following options list:

| | | |
|---|------------|------------|
| 1 | TAX SYSTEM | Tax system |
| 2 | TAX1 | Tax1 |
| 3 | TAX2 | Tax2 |
| 4 | TAX3 | Tax3 |
| 5 | TAX4 | Tax4 |

■ Tax system

Procedure

```

TAX SYSTEM
      AUTO VAT1-4
PGM              01
    
```

• Tax system (Use the selective entry)

- AUTO TAX 1-4
- AUTO VAT 1-4
- MANUAL VAT 1-4
- MANUAL VAT 1
- MANUAL TAX 1-4
- VAT1 & TAX 2-4

■ Tax 1 through 4

Procedure

```

TAX1
TAX RATE        0.0000%
RATE SIGN      +
LOWER TAX       0.00
PGM              01
    
```

• TAX RATE (Use the numeric entry)

Tax rate (max. 7 digits: 0.0000 to 999.9999%)

• RATE SIGN (Use the selective entry)

- + : Plus rate
- : Minus rate
- This option is not available in the VAT system.

• LOWER TAX (Use the numeric entry)

Lowest taxable amount (max. 5 digits: 0.00 to 999.99)

- This option is not available in the VAT system.

Automatic Sequencing Key Programming

If you program frequently performed key operations for the AUTO keys, you can enter those key operations simply by pressing the corresponding AUTO keys in key operations.

Procedure

```
SETTING ▲
9 REPORT
10 MESSAGE
11 DEVICE CONFIG
12 TAX
13 AUTO KEY
PGM ○1
```



```
AUTO KEY
1 KEY TEXT
2 KEY SEQUENCE
PGM ○1
```



```
KEY TEXT
1 AUTO 1
2 AUTO 2
3 AUTO 3
4 AUTO 4
5 AUTO 5
PGM ○1
```



```
AUTO 1
TEXT                   ▲ AUTO 1
PGM                   ▲ ○1
```

■ Key Text

1. In the SETTING window, select "13 AUTO KEY."
 - The AUTO KEY window will appear.
2. Select "1 KEY TEXT" by the TL/NS key.
3. Select the pertinent Auto key from the key list by the TL/NS key.
4. Enter the title of the operation for the key sequence to allocate.
TEXT: up to 12 digits

■ Key Sequence

Procedure

```

SETTING                               ▲
 9 REPORT
10 MESSAGE
11 DEVICE CONFIG
12 TAX
13 AUTO KEY
PGM                                01
  
```



```

AUTO KEY
1 KEY TEXT
2 KEY SEQUENCE
PGM                                01
  
```



```

KEY SEQUENCE
1 AUTO 1
2 AUTO 2
3 AUTO 3
4 AUTO 4
5 AUTO 5
PGM                                01
  
```



```

AUTO 1
PGM                                01
  
```

1. In the SETTING window, select "13 AUTO KEY."
• The AUTO KEY window will appear.
2. Select "2 KEY SEQUENCE" by the key.
3. Select the pertinent Auto key from the key list by the key.
4. Enter the key operation sequence by any key except the key.
The register allows to program up to 25 keys for each AUTO key.
5. To terminate the procedure press the key, the confirmation window will appear for sequence data saving. Select "SAVE" or "ABANDON" and press the key.

Example

In case of the X1 General report printing.

Display

```

AUTO 1
4 2 KEY
5 TL/NS
6 1 KEY
7 ESC/CANCEL
8 ESC/CANCEL
PGM                                01
  
```

Key operation

```

4=(select X1/Z1 MODE)

2=(select READING)

1=(select GENERAL)



  
```

Reading of Stored Programs

You can read programs stored in the PGM mode.

■ Program reading sequence

To read those programs stored in the PGM mode, use the following procedure:

1. Select the PGM mode from the mode selection window.
2. Select "1 READING" from the PGM mode to display the items list, and press the key.

Select an item listed in the table shown later.

| Item: | Description: |
|------------------|---------------------|
| 1 DEPARTMENT | Department |
| 2 PLU | PLU |
| 3 FUNCTIONS | Function |
| 4 MEDIA | Media |
| 5 FUNCTION TEXT | Function Text |
| 6 CLERK | Clerk |
| 7 MANAGER | Manager |
| 8 MODE PASS CODE | Mode pass code |
| 9 TRAINING CLK | Training clerk |
| 10 OPTIONAL | Optional |
| 11 REPORT | Report |
| 12 MESSAGE | Message |
| 13 DEVICE CONFIG | Device config. |
| 14 TAX | Tax |
| 15 AUTO KEY | Auto key |
| 16 ROM VERSION | ROM version |

■ Sample printouts

• Departments (PGM mode)

| Operating mode | *PGM* | | | Tax status |
|----------------|------------|------------|----|---|
| Report type | DEPARTMENT | | | Unit price |
| Dept. code | D01 | T1 | 01 | 0.00 |
| Description | DPT. 01 | L999999.99 | | Function programming |
| Group no. | G01 | | | 01 Amount entry type (0:Inhibit 1:Open 2:Preset 3:Open&Preset) |
| | D02 | T1 | 03 | 12.00 |
| | DPT. 02 | L999999.99 | | SICS (0:No 1:Yes) |
| | G01 | | | HALO limit |
| | D03 | | | 0.00 |
| | DPT. 03 | T1 | 01 | |
| | G01 | L999999.99 | | |

• PLU (PGM mode)

| Report type | *PGM* | | | Associated dept code |
|-------------|----------|------|------|----------------------|
| PLU code | PLU | | | Amount Entry type |
| Description | P00001 | (01) | 2 | Price |
| | PLU00001 | | 1.20 | |
| | P00002 | (02) | 2 | |
| | PLU00002 | | 4.50 | |
| | P00003 | (02) | 2 | |
| | PLU00003 | | 3.10 | |
| | P00004 | (01) | 2 | |
| | PLU00004 | | 4.50 | |
| | P00005 | (01) | 2 | |
| | PLU00005 | | 2.25 | |
| | P00006 | (01) | 2 | |
| | PLU00006 | | 0.00 | |
| | P00007 | (02) | 2 | |
| | PLU00007 | | 2.10 | |
| | P00008 | (01) | 2 | |
| | PLU00008 | | 1.20 | |
| | P00009 | (01) | 2 | |
| | PLU00009 | | 0.00 | |
| | P00010 | (02) | 2 | |
| | PLU00010 | | 8.20 | |

• Functions (PGM mode)

| *PGM* | |
|-----------|-------------|
| FUNCTIONS | |
| (-) | -0.00 |
| IS | L2.00 |
| %1 | -0.00% |
| S | L100.00% |
| %2 | -0.00% |
| I | L100.00% |
| ***RA | L9999999.99 |
| ***PO | L9999999.99 |
| ***CID | L9999999.99 |
| CHK/CG | L999999.99 |
| CA/CHK | L999999.99 |

Report type
 Sign (plus/minus)
 Text
 Type I=Item S=Subtotal
 Rate
 HALO limit

• Media (PGM mode)

| *PGM* | |
|-------------|---------------|
| MEDIA | |
| CASH | L999999.99 00 |
| CHECK1 | L999999.99 00 |
| CHECK2 | L999999.99 00 |
| CREDIT1 | L999999.99 00 |
| CREDIT2 | L999999.99 00 |
| PRESET RATE | ENABLE |
| EXCH1 | 1.550220 2 |
| OPEN RATE | ENABLE |
| EXCH2 | 2 |

Report type
 HALO
 Text
 Programming data(00)
 Entry of amount tendered
 (0:Non-Compulsory, 1:Compulsory)
 Footer print on receipt
 (0:No, 1:Yes)
 Programming data(00)
 Footer print on receipt
 (0:Inhibit, 1:Compulsory)
 Tab
 Entry of amount tendered
 (0:Inhibit, 1:Compulsory)
 Footer print on receipt
 (0:No, 1:Yes)
 Rate

• Function Text (PGM mode)

| *PGM* | | |
|---------------|--------------|-------------|
| FUNCTION TEXT | | Report type |
| | | Function |
| NET 1 | NET 1 | Text |
| TAX1 ST | TAX1 ST | |
| TAX2 ST | TAX2 ST | |
| TAX3 ST | TAX3 ST | |
| TAX4 ST | TAX4 ST | |
| VAT 1 | VAT 1 | |
| VAT 2 | VAT 2 | |
| VAT 3 | VAT 3 | |
| VAT 4 | VAT 4 | |
| TTL TAX | TTL TAX | |
| NET | NET | |
| NET2 | NET2 | |
| REFUND | REFUND | |
| VOID | VOID | |
| VOID MODE | VOID MODE | |
| MGR VOID | MGR VOID | |
| SBTL VOID | SBTL VOID | |
| HASH VOID | HASH VOID | |
| HASH RF | HASH RF | |
| BILL CNT | BILL CNT | |
| NO SALE | NO SALE | |
| SCM(+) | SCM(+) | |
| SCM(-) | SCM(-) | |
| GUEST | GUEST | |
| PAID TL | PAID TL | |
| AVE. | AVE. | |
| DOM. CUR1 | DOM. CUR1 | |
| DOM. CUR2 | DOM. CUR2 | |
| *CH ID | *CH ID | |
| CA/CHK ID | CA/CHK ID | |
| GROUP01 | GROUP01 | |
| GROUP02 | GROUP02 | |

| | |
|-------------|-------------|
| GROUP03 | GROUP03 |
| GROUP04 | GROUP04 |
| GROUP05 | GROUP05 |
| GROUP06 | GROUP06 |
| GROUP07 | GROUP07 |
| GROUP08 | GROUP08 |
| GROUP09 | GROUP09 |
| *DEPT TL | *DEPT TL |
| DEPT (-) | DEPT (-) |
| *HASH TL | *HASH TL |
| HASH (-) | HASH (-) |
| ***TOTAL | ***TOTAL |
| SUBTOTAL | SUBTOTAL |
| SCM TTL | SCM TTL |
| # | # |
| ITEMS | ITEMS |
| MDSE ST | MDSE ST |
| NET 1 | NET 1 |
| NET 2 | NET 2 |
| NET 3 | NET 3 |
| NET 4 | NET 4 |
| DUE | DUE |
| CHANGE | CHANGE |
| COPY | COPY |
| BILL | BILL |
| RCP SW. | RCP SW. |
| VAT SFT | VAT SFT |
| TAX DELE | TAX DELE |
| ***PBAL | ***PBAL |
| ***NBAL | ***NBAL |
| ORDER TL | ORDER TL |
| O-P | O-P |
| OLD BAL. | OLD BAL. |
| BALANCE | BALANCE |
| GLU# | GLU# |

• Clerk (PGM mode)

| *PGM* | |
|--------|-------------------|
| CLERK | |
| CLK#01 | CLERK01 0 0000 |
| CLK#02 | CLERK02 0 0000 |
| CLK#03 | CLERK03 0 0000 |
| CLK#04 | CLERK04 0 0000 |

Report type
 Clerk code
 Clerk name
 Auto key operation/Pass code
 (0:Enable)
 (1:Disable)

• Manager (PGM mode)

| *PGM* | |
|-----------|------|
| MANAGER | |
| PASS CODE | 9999 |

Report type
 Pass code

• Mode Pass Code (PGM mode)

| *PGM* | |
|----------------|------|
| MODE PASS CODE | |
| VOID MODE | 1111 |
| OPXZ | 0000 |
| FLASH | 0000 |
| X1 | 0000 |
| Z1 | 0000 |
| X222 | 0000 |
| PGM | 1234 |
| SD CARD | 7777 |

Report type
 Mode
 Pass code

• Training clerk (PGM mode)

| *PGM* | |
|--------------|----------|
| TRAINING CLK | |
| CODE | 00 |
| TEXT | TRAINING |

Report type
 Training clerk code
 Training mode title text

• Optional (PGM mode)

| *PGM* | | |
|------------------|------------|-------------|
| OPTIONAL | | Report type |
| BASIC SYSTEM | | Item |
| DATE FORMAT | DMY | |
| TIME FORMAT | 24-HOUR | Setting |
| ERROR | LOCK ERROR | |
| CURRENCY SYMBOL | * | |
| TAB | 2 | |
| DECIMAL QUANTITY | YES | |
| DECIMAL ROUND | ROUND | |
| HALO FUNC. | INVALID | |
| [00]KEY | [00] | |
| PRT/DSP EDIT | YES | |
| ITEM DISPLAY | 2-LINE | |
| ROUNDING | | |
| ROUND100 | NORMAL | |
| ROUND10 | 00 | |
| ROUND FOR | ITEM&TOTAL | |
| CH/CR ROUND | YES | |
| ROUND PRINT | NO | |
| DIFFER MEMORY | NO | |
| ITEM ENT | ANY | |
| PAYMENT ENT | ANY | |
| FUNC. PROHIBIT | | |
| NON-ADD | ENABLE | |
| NON-ADD + NS | ENABLE | |
| MINUS DEPT | ENABLE | |
| HASH DEPT | ENABLE | |
| COPY RCPT | ENABLE | |
| VOID MODE | ENABLE | |
| SUBTOTAL<0 | ENABLE | |
| TEND+DIRECT | ENABLE | |
| FUNC. AUTHORITY | | |
| RA | PUBLIC | |
| PO | PUBLIC | |

| | |
|-------------------|-----------|
| PRINT SELECT | |
| CONSECUTIVE NO. | YES |
| DATE | YES |
| TIME | YES |
| PURCHASE NO. | NO |
| TAX STATUS | NO |
| TAXABLE | YES |
| TAX | YES |
| TAX(TAXABLE=0) | NO |
| TAX(TAX=0) | NO |
| NET | YES |
| SPLIT ENTRY | FORMAT1 |
| ST AT ST KEY | NO |
| LOGO FORM | PATTERN6 |
| FOOTER | ALL |
| O AMT PLU | TEXT ONLY |
| ITEM JOURNAL | ALL |
| LOGO ON JOURNAL | NO |
| BILL ON JOURNAL | NO |
| EXCHANGE FUNCTION | |
| PAY FOR EX1 | CASH |
| EX1 CALC. | MULTI. |
| TTL&CHANGE | DOMESTIC |
| ST SHORT TEND | PRINT |

• Report (PGM mode)

| *PGM* | |
|-----------------|-------|
| REPORT | |
| 0 SKIP | |
| DEPARTMENT | SKIP |
| TRANSACTION | SKIP |
| PLU | SKIP |
| CLERK | SKIP |
| HOURLY | SKIP |
| PRINT SELECT | |
| SEPARATOR LINE | YES |
| Z COUNTER | YES |
| GT1 ON Z | YES |
| GT2 ON Z | YES |
| GT3 ON Z | YES |
| BAL GT ON Z | YES |
| TR GT ON Z | YES |
| GT1 ON X | NO |
| GT2 ON X | NO |
| GT3 ON X | NO |
| TR GT ON X | NO |
| VD MODE ON X1Z1 | YES |
| VD MODE ON X2Z2 | YES |
| PLU DATA ON Z | YES |
| EJ DATA ON Z | YES |
| EJ SIZE | SMALL |

| | |
|-------------------|---------|
| Z COUNTER | |
| GENERAL Z1 | 0000 |
| GENERAL Z2 | 0000 |
| Z1 GENERAL REPORT | |
| SD: SAVE SALES | NO |
| SD: SAVE EJ | NO |
| SD: SAVE ALL RAM | NO |
| CLEAR EJ | NO |
| RESET BAL GT | NO |
| RESET GT | NO |
| HOURLY REPORT | |
| MEMORY TYPE | 30MIN |
| START TIME | 00 |
| E. JOURNAL | |
| STORE TO SD | W SPACE |
| TR DATA STORE | NO |
| X DATA STORE | HEADER |

• Message (PGM mode)

| *PGM* | |
|-----------------|--|
| MESSAGE | |
| RECEIPT LOGO | |
| THANK YOU | |
| FOR YOUR | |
| PURCHASE | |
| WE ARE LOOKING | |
| FORWARD TO | |
| YOUR NEXT VISIT | |

• Device configuration (PGM mode)

| *PGM* | |
|---------------|--------|
| DEVICE CONFIG | |
| KEYBOARD | |
| BUFFERING | YES |
| TOUCH SOUND | YES |
| DISPLAY | |
| POWER SAVE | 2 |
| P. SAVE AT TM | YES |
| PRINTER | |
| DENSITY | 50 |
| ONLINE | |
| TERMINAL No. | 000001 |
| CI SIGNAL | NON |
| LINE FORM | FULL |
| BAUD RATE | 19200 |
| START CODE | 002 |
| END CODE | 013 |
| TIME OUT | 007 |

Report type

Setting

Item

• Tax rate (PGM mode)

| *PGM* | |
|------------|-------------|
| TAX | |
| TAX SYSTEM | AUTO TAX1-4 |
| TAX1 | 1.0000 % |
| | 0.01 |
| TAX2 | 2.0000 % |
| | 0.02 |
| TAX3 | 3.0000 % |
| | 0.03 |
| TAX4 | 4.0000 % |
| | 0.04 |

Report type

Tax no.

Tax system

Rate

Lowest taxable amount

• AUTO key (PGM mode)

| *PGM* | |
|----------|------------|
| AUTO KEY | |
| AUTO 1 | AUTO 1 |
| | P00001 |
| | P00008 |
| | P00015 |
| | P00022 |
| | P00029 |
| | L1 |
| | L2 |
| | L3 |
| | GLU |
| | NBAL |
| | TL/NS |
| | #/TM/ST |
| | CHECK1 |
| | CREDIT1 |
| | DEPT# |
| | CL |
| | 9 KEY |
| | 6 KEY |
| | 3 KEY |
| | 2 KEY |
| | PAYMENT MN |
| | VAT SHIFT |
| | REFUND |
| | 0 KEY |
| | 1 KEY |
| AUTO 2 | AUTO 2 |
| | ---- |
| AUTO 3 | AUTO 3 |
| | ---- |
| AUTO 4 | AUTO 4 |
| | ---- |
| AUTO 5 | AUTO 5 |
| | ---- |

Report type

AUTO key no.

Auto key text

Key operation

• ROM version (PGM mode)

| *PGM* | |
|-----------------|--------------------|
| VERSION | |
| IPL Version | XE-A207 1.00 |
| PROGRAM Version | XE-A207/A217 V1.05 |
| TEXT Version | Text V1.00 |
| SYSTEM Version | System V1.00 |

Report type

SD CARD Mode

The register's data can be saved to the SD memory card, and the programming data can be loaded from the SD memory card.

To use the SD card function, select the "7 SD CARD MODE" in the mode selection window and perform the following operations.

■ Inserting and removing an SD memory card

The SD card slot is located on the front side of your register.

Inserting an SD memory card

Insert an SD memory card into the SD card slot with the printed SD logo facing upwards. Push the card in steady with a finger until it clicks and release it slowly.

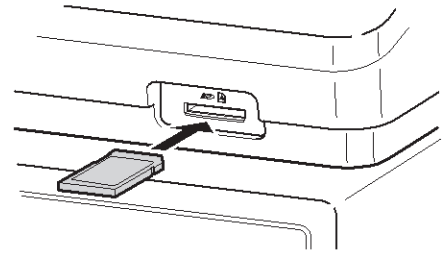

Removing the SD memory card

Push in the card gently with a finger and release it. The card will come out.

NOTE

- This model supports SD cards only. Use of any other types of SD cards such as mini SD, micro SD, etc. with an adapter is not supported.
- When inserting or removing the SD memory card, be sure to release it slowly. Otherwise, the card may pop out and injure your finger.
- Never touch or remove the SD memory card while it is accessed, otherwise the data stored in it may be damaged.
- Formatting the SD memory card erases all the data in it.

CAUTION Never turn the power off, while the SD memory card is accessed.

■ SD card formatting

When the SD card is not formatted yet, take the formatting operation.

Procedure

- (1) Select "4 FORMATTING" in the SD CARD mode, the confirmation window is displayed.
- (2) To perform the format operation, select OK and press the **[TL/NS]** key.
To cancel the operation, select CANCEL and press the **[TL/NS]** key.

■ Folder creating

The master folder can be created for the data file.

(¥ SHARP¥ ECRXXX11¥ nnnnnnnn¥ : nnnnnnnn/folder name)

Procedure

- (1) Select "3 FOLDER CONTROL" in the SD CARD mode and press the **[TL/NS]** key.
- (2) Select "1 CREATE FOLDER", the folder name entry window is displayed.
- (3) Enter the required folder name and press the **[TL/NS]** key.
To cancel the operation, press the **[ESC/CANCEL]** key.

■ Folder name selecting

Procedure

- (1) Select "3 FOLDER CONTROL" in the SD CARD mode and press the **[TL/NS]** key, the FOLDER CONTROL window is displayed.
- (2) Select "2 SELECT FOLDER", the folder name list window is displayed.
- (3) Select the required folder name from the list, and press the **[TL/NS]** key.
To cancel the operation, press the **[ESC/CANCEL]** key.

■ Data saving

The sales data, EJ data or programming data can be saved to the SD card.

Procedure

- (1) Select "1 SAVING" in the SD CARD mode, the selection window "SAVE" or "SAVE FOR ONLINE" is displayed.
 1. SAVE: Saves data
 2. SAVE FOR ONLINE: Saves and adds data to existing file and clears the data at the registerSelect the operation "SAVE" or "SAVE FOR ONLINE" and press the **[TL/NS]** key; the following data list window is displayed. (If you selected "SAVE FOR ONLINE", only "EJ DATA" is displayed.)

| Text | Data list |
|--------------|--|
| SALES DATA | Sales data (CSV format) |
| EJ DATA | Electronic journal data |
| IND. PROGRAM | Select the individual programming data: DEPARTMENT, PLU, GRAPHIC LOGO LOGO TEXT TAX |
| ALL PROGRAM | All programming data |
| ALL RAM DATA | All RAM data |

- (2) Select the data menu from the list and press the **[TL/NS]** key, the confirmation window is displayed.
To save the required data file, select OK and press the **[TL/NS]** key.
To cancel the operation, select CANCEL and press the **[TL/NS]** key.

■ Data loading

The programming data can be loaded from the SD card.

Procedure

- (1) Select "2 LOADING" in the SD CARD mode and the press **[TL/NS]** key. The following selection window is displayed.

| Text | Data list |
|---------------|--|
| IND. PROGRAM | Select the individual programming data: DEPARTMENT, PLU, GRAPHIC LOGO LOGO TEXT TAX |
| ALL PROGRAM | All programming data |
| ALL RAM DATA* | All RAM data |

- (2) Select the data menu from the list and press the **[TL/NS]** key, the confirmation window is displayed.
To load the programming data file, select OK and press the **[TL/NS]** key.
To cancel the operation, select CANCEL and press the **[TL/NS]** key.

* When "ALL RAM DATA" is selected, the register resets the program in the last save point after loading all the RAM data.

NOTE *The loading operation must be circumspect in execution, the sales data and/or all programming data will be recovered with the back-up data.*

11 Electronic Journal

■ Electronic journal

This function is intended to record the journal data in the electronic journal file (memory) instead of journal paper.

• Recording data

The register records the printing output to the journal printer in all modes into the electronic journal file.

• Reporting (X report)

The register reports the journal data (same as normal journal formats) in the electronic journal file by the report printer.

Operation: Select the reading operation "E.JOURNAL" in X1/Z1 or OPXZ (only printing) mode.

It is possible to use filter functions (consecutive no./date/time/clerk code).

C.C. No. (Consecutive no.): ALL or RANGE (designate start no./end no.)

DATE (Date): ALL or RANGE (designate start date/end date)

TIME (Time): ALL or RANGE (designate start time/end time)

CLERK (Clerk code): ALL or INDIVIDUAL (designate clerk code)

• Resetting (Z report)

It is possible to take the resetting report of the journal data in the electronic journal file by the report printer.

Operation: Select the resetting operation "E.JOURNAL" in X1/Z1 or OPXZ mode.

The filter functions (consecutive no./date/time/clerk code) can not be used.

12 EURO Migration Function

Basically your register can be automatically modified to correspond to the introduction of EURO by executing the operation "EURO STATUS" in X2/Z2 mode. However, there are several options you must set depending on your need. Carefully conduct necessary settings.

EURO status:

You can select status from following 4 types ((A), (B), (C), or (D)). And the selectable type is decided as follows for each status. Type (A) is the base status (initial status).

From type (A) — selectable —> Type (B), (C), or (D)
 From type (B) — selectable —> Type (C), (D)
 From type (C) — selectable —> Type (D)

| | Items | Type (B) | Type (C) | Type (D) |
|----|---|-----------------------|--------------------------------------|-----------------------|
| 1 | General Z1 report | ISSUE | ISSUE | ISSUE |
| 2 | General Z2 report | ISSUE | ISSUE | ISSUE |
| 3 | GT1/2/3 & Training GT | — | CLEAR | CLAER |
| 4 | Convert the unit price of DEPT/PLU* | — | CONVERTING | CONVERTING |
| 5 | EX1 AMOUNT PRINTING FOR TOTAL AND CHANGE | YES | YES | NO |
| 6 | EX1 CALCULATTION METHOD | DIVISION | MULTI. | MULTI. |
| 7 | EX1 currency symbol | [EURO] | The current domestic currency symbol | — |
| 8 | EX1 TAB | 2 | The current domestic TAB | — |
| 9 | Domestic currency symbol | — | [EURO] | [EURO] |
| 10 | Domestic TAB | — | 2 | 2 |
| 11 | Rounding SYSTEM (Denmark/Sweden/Normal) | — | Normal | Normal |
| 12 | Rounding up/down of the unit digits of AMOUNT | — | No | No |
| 13 | Lowest digit entering limitation of item | — | Arbitrary | Arbitrary |
| 14 | Lowest digit entering limitation of payment | — | Arbitrary | Arbitrary |
| 15 | Difference memory | — | No | No |
| 16 | Rounding of foreign currency for EX1 | ROUND OFF (4DOWN-5UP) | ROUND OFF (4DOWN-5UP) | ROUND OFF (4DOWN-5UP) |

The marked items "—" is remaining the current data.

*: The preset rate of the Exchange1 is applied as the conversion rate, and the calculation method is set to "division". When the conversion has been made, the message "PRICE CONVERTED" is printed on the report.

Setting the date and time when the automatic EURO modification operation should be executed

To certainly execute the automatic modification operation, you can program the scheduled date and time to execute the automatic EURO modification operation. From ten days before the preset date, the remaining days are printed at the bottom of the daily full resetting report.

| | |
|------------------|---------|
| ****CID | *191.00 |
| *CH ID | *10.00 |
| CA/CHK ID | *201.00 |
| CHK/CG | *4.00 |
| ----- | |
| EURO START | |
| 01/06/2011 10:00 | |
| DAYS TO EURO | <10> |
| ----- | |

Date and time setting will be reset after the execution of automatic modification operation, and again you can program the date and time for the next automatic modification operation.

Also you can make the automatic EURO modification operation compulsory. When the above-mentioned preset date and time has come, and also when you start an entry in the REG/MGR mode, the error message "EURO CHANGE ENTRY COMPULSORY" will be displayed. You cannot start any operation in the REG/MGR mode until you make the operation.

Automatic EURO modification operation

1. Select "5 X2/Z2 MODE".
2. Select "3 EURO STATUS" from the menu.
3. Select the status you want to set (B, C or D) referring to the table on the previous page. Press the key to toggle the options.

Please note that once you set a status, you cannot return to the previous status(es).

Important note

As for the miscellaneous keys, such as and keys, and for the HALO setting, the automatic conversion will not be made. You need to change the % rates or amounts in the PGM mode after the execution of the automatic modification operation for EURO so that they are based on amounts in EURO.

NOTE

It is executed some of following operation which is needed for each status.

- 1) Issue General Z1 report.
- 2) Issue General Z2 report.
- 3) Clear GT1/2/3 and Training GT.
- 4) Convert the unit price of DEPT/PLU from LOCAL currency to EURO. If new unit price is over the max digits, its price is set as "0.00".
- 5) Change PGM function "EX1 AMOUNT PRINTING FOR TOTAL AND CHANGE YES/NO".
- 6) Change PGM function "EX1 CALCULATTION METHOD DIVISION/MULTIPLICATION".
- 7) Set "EX1 currency symbol" as the suitable data.
- 8) Set "EX1 TAB" as the suitable data.
- 9) Set "Domestic currency symbol" as EURO SYMBOL.
- 10) Set "Domestic TAB" as "2".
- 11) Set "Rounding SYSTEM (Denmark/Sweden/Normal)" as "Normal".
- 12) Set "Rounding up/down of the unit digits of AMOUNT" as "No".
- 13) Set "Lowest digit entering limitation of item" as "Arbitrary".
- 14) Set "Lowest digit entering limitation of payment" as "Arbitrary".
- 15) Set "Difference memory" as "No".
- 16) Set "Rounding of foreign currency for EX" as "Round off(4-DOWN,5-UP)". (EURO Regulation)

NOTE

This job cannot set the following additional EURO function. You must set the following items by each programming after executing the automatic EURO modification operation.

- 1) Exchange1 rate, (2) "Check, Credit operation for Exchange1 — YES/NO"

13 Operator Maintenance

In Case of Power Failure

When power is lost, the register retains its memory contents and all information on sales entries.

- When power failure is encountered in register idle state or during an entry, the register returns to the normal state of operation after power recovery.
- When power failure is encountered during a printing cycle, the register carries out the correct printing procedure after power recovery.

In Case of Printer Error

If the printer runs out of paper, the printer will stall, and "PAPER EMPTY" will appear on the display. Key entries will not be accepted. Referring to "Replacing the Paper Roll" in this chapter, install a new paper roll in the proper position, then press the **CL** key. The printer will print the power failure symbol and resume printing.

If the print roller arm comes up, the printer stalls, and "PAPER EMPTY" will appear on the display. Key entries will not be accepted. Push down the arm until it is securely locked, then press the **CL** key. The printer will print the power failure symbol and resume printing.

Cautions in Handling the Printer and Recording Paper

■ Cautions in handling the printer

- Avoid the following environments:
 - Dusty and humid places
 - Direct sunlight
 - Iron powder (A permanent magnet and electromagnet are used in this machine.)
- Never pull the paper when the print roller arm is locked. First lift up the arm, and then remove the paper.
- Never touch the surface of the printer head and print roller.

■ Cautions in handling the recording paper (thermal paper)

- Use only the paper specified by SHARP.
- Do not unpack the thermal paper until you are ready to use it.
- Avoid heat. The paper will color at around 70°C.
- Avoid dusty and humid places for storage. Avoid direct sunlight.
- The printed text on the paper can discolor under the following conditions:
 - Exposure to high humidity and temperature
 - Exposure to the direct sunlight
 - Contact with glue, thinner or a freshly copied blueprint.
 - Heat caused by friction from scratching or other such means.
 - Contact with a rubber eraser or adhesive tape.
- Be very careful when handling the thermal paper. If you want to keep a permanent record, copy the printed text with a photocopier.

Installing Batteries

This register displays a low battery warning message "LOW BATTERY" when the batteries are low, and displays a no battery warning message "NO BATTERY" when batteries are extremely low or batteries are not installed.

If no batteries are installed, install two new alkaline batteries LR6 ("AA" size) at once. If batteries are already installed, replace them with new ones as soon as possible. If the AC power cord is disconnected or a power failure occurs when the batteries are dead or not installed, all the programmed settings will be reset to the default settings and any data stored in memory will be cleared.

NOTE *Improper use of batteries could cause them to burst or leak, which might damage the interior of the register. Please take the following precautions:*

- *Be sure that the positive (+) and negative (-) poles of each battery are oriented properly.*
- *Never mix batteries of different types.*
- *Never mix old batteries and new ones.*
- *Never leave dead batteries in the battery compartment.*
- *Remove the batteries if you plan not to use the register for long periods.*
- *Should a battery leak, clean out the battery compartment immediately, taking care not to let the battery fluid come into direct contact with your skin.*
- *If an incorrect battery is used, it may explode or leak.*
- *For battery disposal, follow the relevant law or regulation in your country.*

Replacement

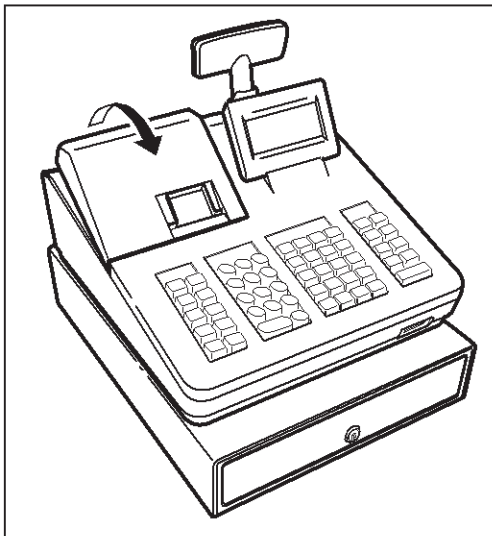

1. Be sure the register is plugged in.
2. Remove the printer cover.

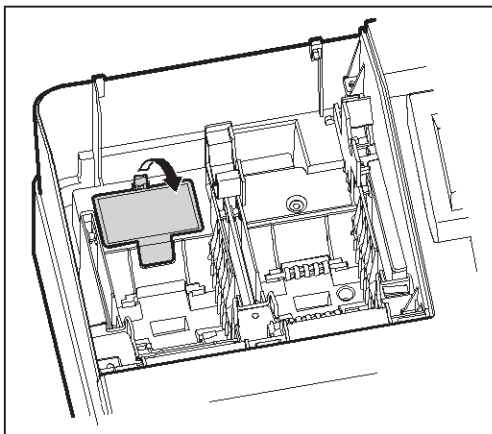

3. Open the battery cover and remove the old batteries.

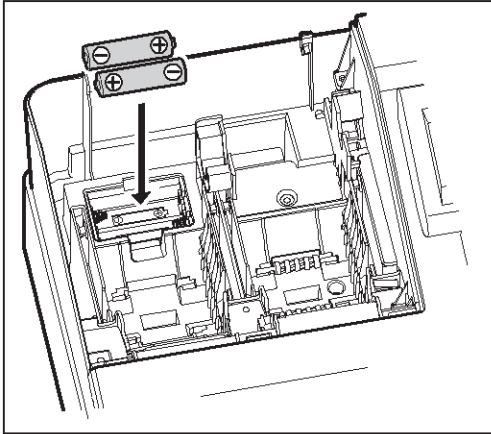

- 4.** Install two new LR6("AA" size) batteries into the battery compartment.
- 5.** Close the battery cover.
- 6.** Replace the printer cover.

Replacing the Paper Roll

■ Recording paper specifications

Be sure to use paper rolls specified by SHARP.

The use of any other paper rolls than specified could cause paper jamming, resulting in register malfunction.

Paper specification

Paper width: 57.5 ± 0.5 mm
Max. outside diameter: 80 mm
Quality: High quality(0.06 to 0.08 mm thickness)

- Be sure to set a paper roll prior to using your machine, otherwise it may cause a malfunction.

Install the paper roll in the printer. Be careful then to set the roll and cut the paper end correctly.

(How to set the paper roll)

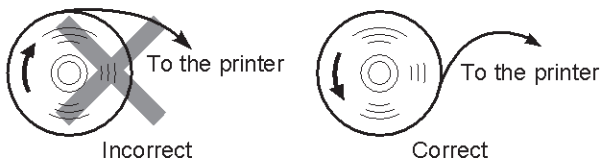

(How to cut the paper end)

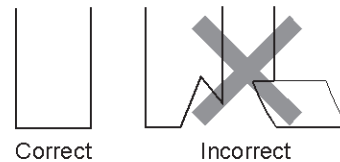

■ Installing the Paper Roll

Always install the paper roll even when you set the register for not printing receipt in REG mode.

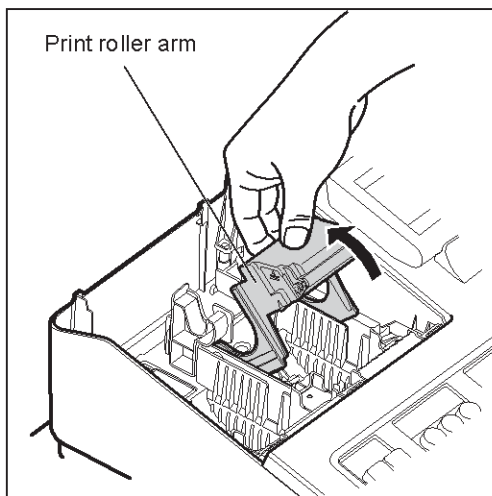

1. Remove the printer cover.
2. Lift up the print roller arm.

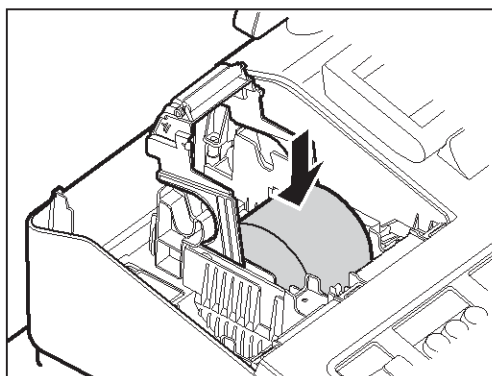

3. Set the paper correctly in the paper roll cradle.

NOTE Before placing a new paper roll in the paper roll cradle, cut off the pasted (taped) part of the paper and confirm that the cut end of the paper is straight.



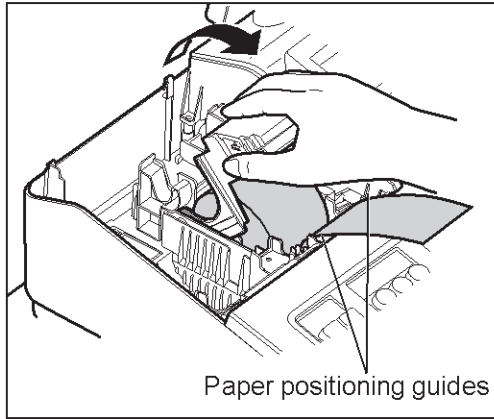

4. Feed the end of the paper along with the paper positioning guides as per the diagram.

5. While holding down the paper, slowly close the print roller arm.

NOTE *If the print roller arm is not securely locked, printing is not done right. If this problem occurs, open the arm, and close the arm as instructed above.*

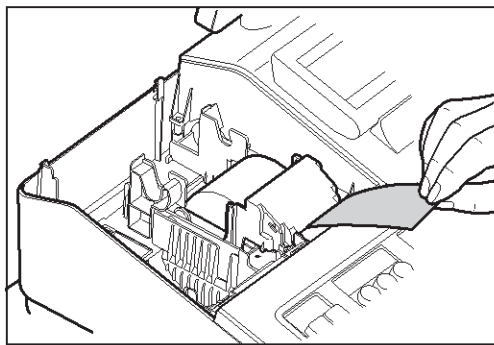

6. Cut off the excess paper and replace the printer cover.

7. Press the **↑ RECEIPT** key to make sure the paper end comes out of the printer cover and clean paper appears.

NOTE *If the paper end does not come out, open the printer cover, and pass the paper end between the paper cutter and the paper guide of the printer cover, and replace the printer cover.*

■ Removing the receipt paper roll

When colored dye appears on the edges of the paper roll, it is time to replace the paper roll. Use paper of 57.5 ± 0.5 mm in width. To prevent jamming be sure to use paper specified by SHARP.

1. Confirm that the REG mode has been selected.
2. Remove the printer cover.
3. Lift up the print roller arm.
4. Remove the remaining paper roll from the paper roll cradle.
5. Install a new paper roll correctly by following the steps in "Installing the Paper Roll."

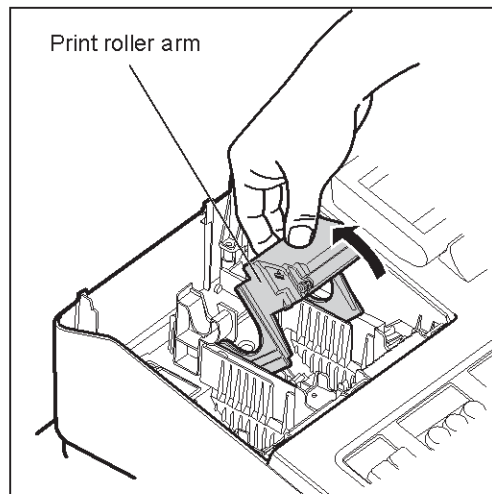

■ Removing the Paper Jam

Caution: The paper cutter is mounted on the printer cover. Be careful not to cut yourself. Never touch the printer head immediately after printing, as the head may still be hot.

1. Remove the printer cover.
2. Lift up the print roller arm.
3. Remove the paper jam. Check for and remove any shreds of paper that may remain in the printer.
4. Reset the paper roll correctly by following the steps in "Installing the Paper Roll."

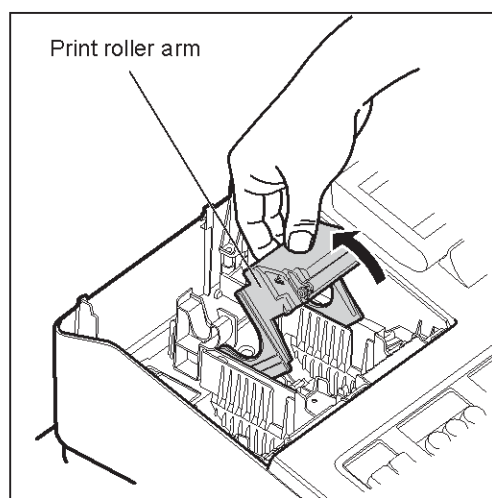

Cleaning the Printer (Printer Head/Sensor/Roller)

When the printed text is getting dark or faint, paper dust may be stuck to the printer head, sensor and/or roller. Clean them as follows:

Caution: Never touch the printer head with a tool or anything hard as it may damage the head. The paper cutter is mounted on the printer cover. Be careful not to cut yourself.

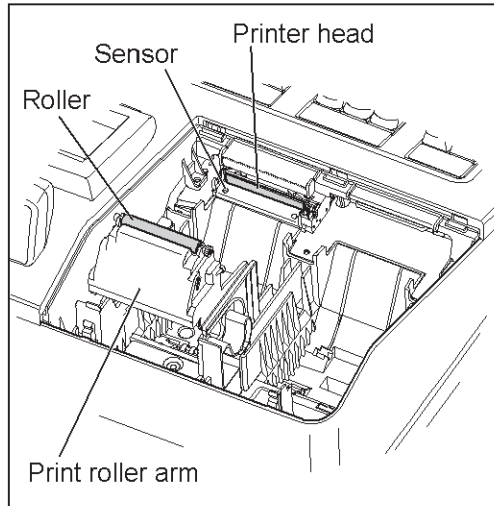

- 1.** Select the OFF mode.
- 2.** Remove the printer cover.
- 3.** Lift up the print roller arm.
- 4.** Remove the paper roll referring to the "Removing the paper roll" section.
- 5.** Clean the printer head with a cotton swab or soft rag moistened with ethyl alcohol or isopropyl alcohol. Clean the roller and the sensor in the same manner.
- 6.** Reset the paper roll correctly by following the steps in "Installing the paper roll."

Removing the Till and the Drawer

The till in the register is detachable. After closing your business for the day, remove the till from the drawer and keep the drawer open. The coin case is also detachable from the till. To detach the drawer, pull it forward fully with the till removed, and remove it by lifting it up.

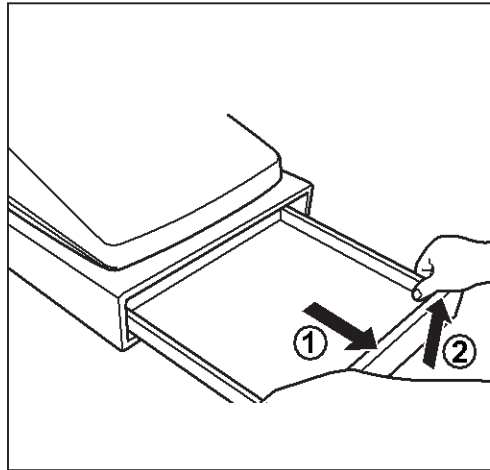
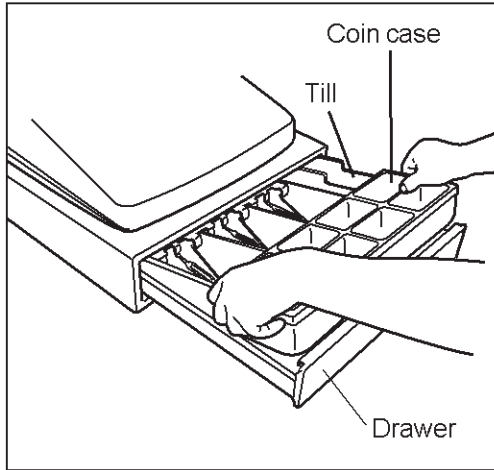

Opening the Drawer by Hand

The drawer automatically opens in the usual way. However, when power failure is encountered or the machine becomes out of order, slide the lever located on the bottom of the machine in the direction of the arrow. (See the figure below.) The drawer will not open, if it is locked with a drawer lock key.

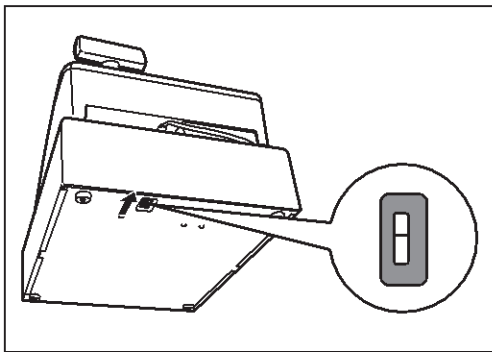

Drawer Lock Key

This key locks and unlocks the drawer.
To lock it, turn 90 degrees counterclockwise.
To unlock it, turn 90 degrees clockwise.

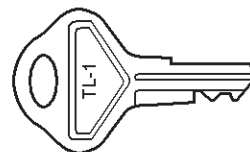

Installing the Fixing Angle Bracket

To prevent the register from moving when the drawer opens, the fixing angle bracket is supplied with the register. By attaching the bracket to the table where the register is installed, you can hook the register on this bracket and secure the register to its position.

How to install the fixing angle bracket

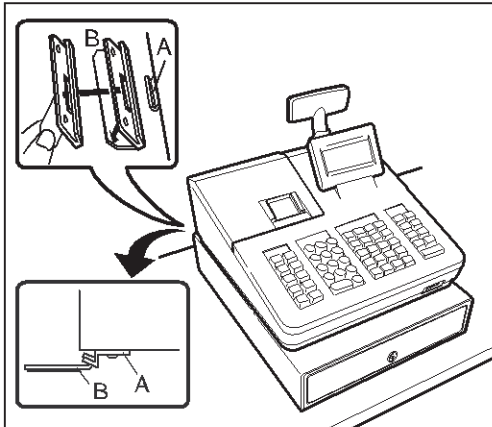

1. Thoroughly clean the location where the fixing angle bracket (B) is to be placed.
2. Peel off the adhesive tape on the fixing angle bracket.
3. Hook the angle bracket onto the hook (A) that is located at the bottom rear of the register.
4. Firmly stick the fixing angle bracket to the table surface that you cleaned above.

How to remove the register from the fixing angle bracket

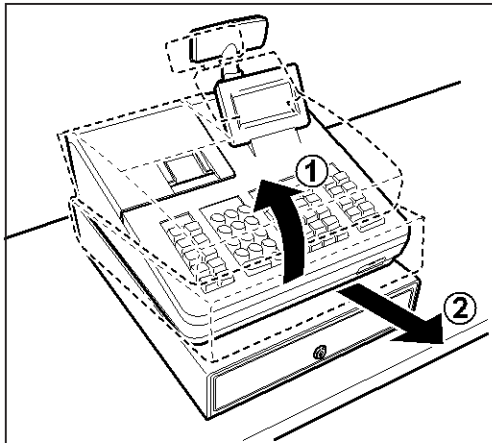

1. Lift up the front of the register and pull the register towards you.

Before Calling for Service

If you encounter any of the following problems, please read below before calling for service.

| Fault | Checking |
|--|--|
| • The display does not illuminate. | • Is power supplied to the electric outlet? • Is the power cord plug out or loosely connected to the electric outlet? • Is the register in screen-save mode? |
| • The display is illuminated, but the whole machine refuses entries. | • Is a clerk code assigned to the register? • Is the register in the REG mode? |
| • No receipt is issued. | • Is the receipt paper roll properly installed? • Is there a paper jam? • Is the receipt function in the "OFF" status? • Is the print roller arm securely locked? |
| • Printing is unusual. | • Are the printer head/sensor/roller clean? • Is the paper roll properly installed? |

14 Specifications

| | | |
|----------------------|---|--|
| Model: | XE-A207W/XE-A207B XE-A217W/XE-A217B | |
| Dimensions: | 360 (W) x 425 (D) x 330 (H) mm | |
| Weight: | Approx. 11.0 kg | |
| Power Source: | Official (nominal) voltage and frequency | |
| Power Consumption: | Stand-by: 7.4 W (When the official voltage is 220 to 230 V, 50 Hz/60 Hz) 7.5 W (When the official voltage is 230 to 240 V, 50 Hz) Operating: 32.4 W (max.) (When the official voltage is 220 to 230 V, 50 Hz/60 Hz) 32.2 W (max.) (When the official voltage is 230 to 240 V, 50 Hz) | |
| Working Temperature: | 0 to 40 °C (32 to 104 °F) | |
| Humidity: | 20 % to 90 % | |
| Display: | Operator display: | LCD display with Tilt mechanism 160 (W) x 64 (H) (dots) |
| | Customer display: | 7-segment display |
| Printer: | Type: | One-station thermal printer |
| | Printing speed: | Approx. 12 lines/second |
| | Printing capacity: | 30 digits |
| | Other functions: | - Receipt (ON-OFF) function - Compression print for an electronic journal |
| Logo: | Graphic logo printing: | |
| | Size: | 130 (H) x 360 (W) pixel Area of black must be less than 35% of all area. |
| | Logo message printing: | |
| | Logo message for the receipt (max. 30 characters x 6 lines) | |
| Paper Roll: | Width: 57.5 ± 0.5 mm Max. diameter: 80 mm Quality: High quality (0.06 to 0.08 mm thickness) | |
| Cash Drawer: | 5 slots for bills and 8 for coin denominations | |
| Accessories: | Basic User Manual: | 1 copy |
| | Standard key sheet: | 1 (placed under keyboard cover) for XE-A217W/XE-A217B only |
| | Programming key sheet: | 1 (placed under keyboard cover) for XE-A217W/XE-A217B only |
| | Paper roll: | 1 |
| | Drawer lock key | 2 |
| | Fixing angle bracket | 1 |
| | Battery caution label | 1 |

*Specifications and appearance are subject to change without notice for improvement.

Warning

This is a Class A product. In a domestic environment this product may cause radio interference in which case the user may be required to take adequate measures.

Achtung

Dies ist ein Gerät der Klasse A. Dieses Gerät kann im Wohnbereich Funkstörungen verursachen; in diesem Fall kann vom Betreiber verlangt werden, angemessene Gegenmaßnahmen durchzuführen und dafür aufzukommen.

Advertencia

Este es un producto de la clase A. En un ambiente doméstico es posible que este producto cause radiointerferencia. En este caso se solicita al usuario que tome medidas adecuadas.

Advertência

Este é um produto de classe A. Num ambiente doméstico este produto pode causar interferência rádio sendo que neste caso o utilizador terá que tomar medidas adequadas.

Avertissement

Ceci est un produit de Classe A. Dans un environnement domestique ce produit risque de provoquer une interférence radio, auquel cas l'utilisateur sera obligé d'observer les mesures adéquates.

Waarschuwing

Dit is een Klasse A-product. Het is mogelijk dat dit product in de huiselijke omgeving radiostoringen veroorzaakt waartegen de gebruiker afdoende maatregelen dient te nemen.

Avvertenza

Questo è un prodotto di Classe A. In un ambiente domestico questo prodotto può causare interferenze radio, nel qual caso l'utilizzatore può essere tenuto a prendere provvedimenti adeguati.

Advarsel

Dette er et klasse A produkt. I et hjemligt miljø kan produktet forårsage radio forstyrrelser, hvor brugeren kan være forpligtet til at træffe passende foranstaltninger.

Advarsel

Dette er et klasse A produkt. Innendørs kan dette produktet skape radioforstyrrelser. I så tilfelle må brukeren iverksette nødvendige tiltak.

Varoitus

Tämä on luokan A tuote. Kotiympäristössä tämä tuote saattaa aiheuttaa radiohäiriötä, jossa tapauksessa käyttäjän on ehkä ryhdyttävä tarvittaviin toimenpiteisiin.

Varning

Detta är en produkt av klass A. I hemmiljö kan produkten störa radiomottagning, i vilket fall användaren kan behöva vidta motåtgärder.

Varování

Toto je výrobek třídy A. Je-li výrobek provozován v domácím prostředí, může způsobovat radiové rušení jiných zařízení a uživatel proto musí provést odpovídající opatření.

Upozorenje

Ovo je proizvod A klase. U domaćem okruženju ovaj proizvod može prouzročiti radio smetnje što može zahtijevati od korisnika da poduzme odgovarajuće mjere.

Varovanie

To je proizvod razreda A. V domaćem okolju lahko ta izdelek povzroči radijske motnje. V tem primeru mora uporabnik ustrezno ukrepati.

Hoiatus

Tegemist on A-klassi tootega. Kodukeskkonnas kasutamisel võib antud toode põhjustada raadiointerferentsi, mis omakorda nõuab kasutajalt sobivate meetmete rakendamist.

Προειδοποίηση

Αυτό είναι ένα προϊόν κατηγορίας Α. Σε ένα εσωτερικό περιβάλλον αυτό το προϊόν μπορεί να προκαλέσει τη ράδιο ακτινοβολία. Σε αυτή την περίπτωση ο χρήστης πρέπει να λάβει επαρκή μέτρα προστασίας.

Uwaga

Urządzenie to jest urządzeniem klasy A. W środowisku mieszkalnym może ono powodować zakłócenia radioelektryczne. W takich przypadkach można żądać od użytkownika zastosowania odpowiednich środków zaradczych.

Upozorenje

Ovo je proizvod klase A. U kućnom okruženju ovaj proizvod može prouzrokovati radio smetnje, u tom slučaju od korisnika se zahteva da preduzme odgovarajuće mere.

FOR CUSTOMERS IN U.K.

IMPORTANT

The wires in this mains lead are coloured in accordance with the following code:

| | |
|---------------|----------------|
| BLUE: | Neutral |
| BROWN: | Live |

As the colours of the wires in the mains lead of this apparatus may not correspond with the coloured markings identifying the terminals in your plug proceed as follows.

The wire which is coloured BLUE must be connected to the terminal which is marked with the letter N or coloured black.

The wire which is coloured BROWN must be connected to the terminal which is marked with the letter L or coloured red.

The apparatus must be protected by a 3A fuse in the mains plug or distribution board.

CAUTION: DO NOT CONNECT THE LIVE (BROWN) WIRE OR THE NEUTRAL (BLUE) WIRE TO THE EARTH TERMINAL OF YOUR 3-PIN MAINS PLUG.

CAUTION:

Shielded interface cables must be used with this equipment to maintain compliance with EMC regulations.

Noise level LpA: 60.7 dB(A-weighted)

Measured according to EN ISO 7779:2001

[Maximum value if the cash drawer springs open LpA: 80.4 dB(A-weighted)]

SHARP

SHARP ELECTRONICS (Europe) GmbH
SonninstraÙe 3, D-20097 Hamburg

SHARP CORPORATION